

Altistart 48 & Enclosed Altistart 48 soft starters

for three-phase asynchronous motors

eCatalog

2014



Schneider
Electric™

This page was intentionally left blank.

■ Introduction	4
□ Applications	4
□ Product.....	5
■ Functions	9
■ Specifications	16
□ Environmental.....	16
□ Electrical	17
□ I/O & Control.....	18
■ Selection Criteria	19
■ Selection Tables	22
□ Normal Duty Applications.....	22
□ Heavy Duty Applications.....	23
■ Dimensions	24
■ Accessories & Options	30
■ Wiring Diagrams	32
■ Suggested Components	36
■ Conventional Starting Curves	38
■ Enclosed Altistart 48	40
□ Introduction	40
□ Applications	40
□ Product.....	41
□ Specifications.....	43
□ Selection Criteria	45
□ Selection Table	48
□ Options.....	49
■ Quality Assurance	52
■ Services & Support	54

Altistart 48

soft starters for asynchronous motors

Introduction



Introduction

The **Altistart™ 48 soft starter** offers advanced electronic soft start - soft stop performance and a six thyristor power configuration to provide smooth torque-controlled acceleration and deceleration for three-phase asynchronous motors between 2 - 1200 HP (3 - 900 kW). The Altistart 48 is rated for three-phase voltages 208 to 690 V, 50/60 Hz, and for normal and heavy duty applications.

The Altistart 48 features a patented advanced motor control algorithm called TCS, or Torque Control System™. Without speed feedback, the Altistart 48 soft starter provides constant starting and stopping rates independent of motor loading, just like a more expensive AC drive. Setting the new industry standard for soft starters, the Altistart 48 controls the applied motor torque, making it ideal for a wider variety of applications than a traditional voltage ramp soft starter with current limit.

In pumping applications, the Altistart 48 uses its Torque Control System to eliminate the long start and stop times, hydraulic transients, and slamming of check valves associated with “pump version” voltage ramp soft starts. The high-performance algorithms of the Altistart 48 contribute significantly to its robustness and ease of setup.

The Altistart 48 is supplied ready for use in a standard duty application with Class 30, Class 25, Class 20 (severe duty application), Class 15, Class 10 (standard duty application), Class 10 A, and sub-class 2 motor thermal overload protection. All devices include a built-in keypad display which can be used to modify the configuration to adapt it to the application and individual customer requirements.

Applications

Altistart 48 soft starters offer soft starting and deceleration functions, machine and motor protection functions, and functions for communicating with control systems. These functions are designed for use in the following normal or heavy duty applications in the buildings, food and beverage, and chemical industries:



Application type	Functions performed by the Altistart 48
Pumps Normal duty	<ul style="list-style-type: none"> ■ Better control of hydraulic transients: <ul style="list-style-type: none"> - Gradual pressurization of fluid in lines - Reduction of pressure surges and valve surges (in presence of line supply) - Elimination of damage to filters or spouts (irrigation) and premature wear of lines, etc. - Less stress on pipes with the reduction of pressure-over pressure phenomena ■ Independent adjustment of the load conditions ■ Protection against underload (running dry), loss or inversion of phases and in the event of a locked rotor ■ Automatic switching of the motor to freewheel mode on stopping, when the flow rate of the pump drops to a low level, to prevent overheating.
Conveyors Normal duty	<ul style="list-style-type: none"> ■ Gradual starting, reducing shocks and slipping of belts ■ Overload control to detect faults, hard spots or jamming, or underload control to detect breaks
Fans & high inertia machines Normal or Heavy duty (>30 s)	<ul style="list-style-type: none"> ■ Smooth starting, preventing stress on the drive chain and slipping of belts ■ “Smoke extraction” function ■ Limitation of current and voltage drops on starting ■ Catching on the fly of a fan rotating in reverse ■ Detection of overload caused by clogging or underload (broken fan motor transmission) ■ Braking torque on stopping
Compressors Normal or Heavy duty (>30 s)	<ul style="list-style-type: none"> ■ Elimination of slipping of belts ■ Reduction of current peaks ■ Protection even for special motors ■ Detection of inversion of direction of rotation of phases ■ Contact for automatic emptying on stopping

Altistart 48

soft starters for asynchronous motors

Introduction



Product

The Altistart 48 is offered in the following voltage range:
ATS48●●●Y for three-phase motors, 208 V to 600 V @ 50/60 Hz

The ATS48 soft starter is a cost-effective solution which can:

- Reduce machine operating costs by reducing mechanical stress and improving machine availability
- Reduce the stress placed on the electrical distribution system by reducing line current peaks and voltage drops during motor starts

These benefits allow you to save costs through more efficient and intelligent use of your application devices while protecting your equipment from other harmful starting and stopping methods.

Smarter starting with Torque Control System

The Altistart 48 offers many strong starting features including the patented Torque Control System (TCS). TCS applies the torque to the motor during the entire starting phase as long as the current required (**Curve 1**) does not exceed the limiting current (**Is1**). With TCS present in the starting process, the accelerating torque can be virtually constant over the entire speed range (**Curve 2**).

With conventional starting using only current limitation (**Is1**), the accelerating torque applied to the motor is equal to the motor torque minus the resistive torque. The accelerating torque increases in the starting range as the speed changes and is at its highest at the end of acceleration (**Curve 4**). This causes the load to be taken up very abruptly, which is not recommended for pump type applications.

It is also possible to configure the Altistart 48 to obtain a high torque on starting, for a rapid motor speed rise while limiting its temperature rise, and a lower torque at the end of starting for gradual loading. This control function is ideal for centrifugal pumps or for machines with high resistive torque on starting.

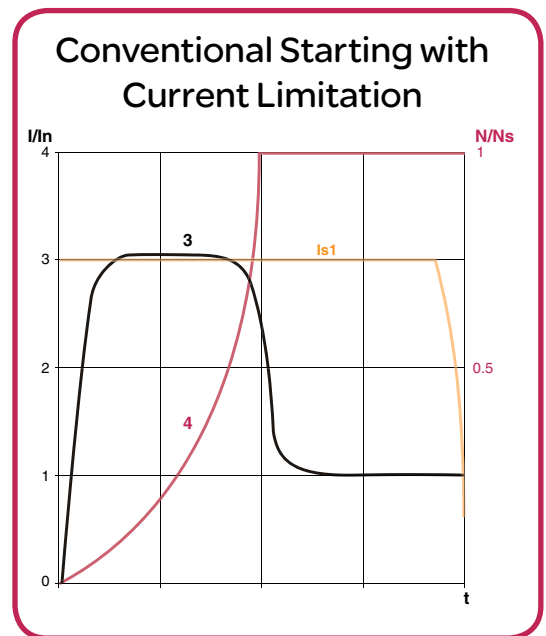
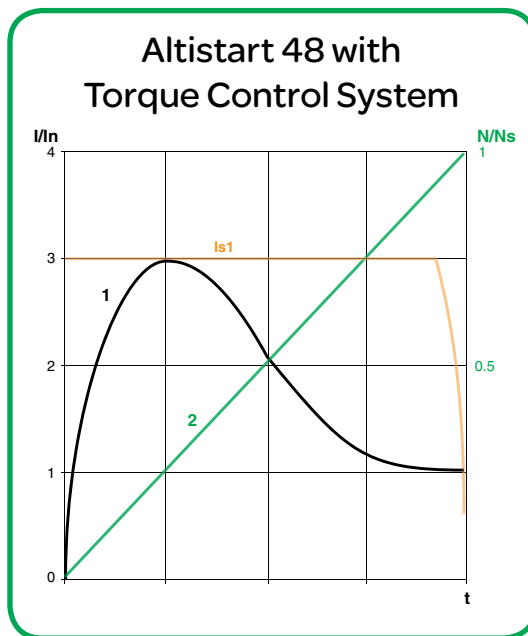

Stopping with the Altistart 48

- **Freewheel stop:** the motor coasts to a complete stop
- **TCS soft stop:** this type of stop is ideal for pumps. It can be used to effectively reduce pressure surges. Torque control on the ATS48 soft starter reduces the effect of hydraulic transients even if the load increases. This type of control makes adjustment easy. Adjustable from 1 to 60 seconds.
- **InTele braking:** this type of stop is suitable for high inertia applications because it reduces the stopping time of the machine.



Product (continued)

Advanced soft starter performance

- Exclusive Torque Control System (TCS) patented by Schneider Electric
- Constant control of the torque supplied to the motor during acceleration and deceleration periods (significantly reducing pressure surges)
- Adjustments for ramp and the starting torque
- The soft starter can be bypassed using a contactor at the end of the starting period while maintaining electronic overload protection (bypass function)
- Wider frequency tolerance for generator set (source) power supplies

Intelligent machine and motor protection

- Built-in motor thermal overload protection
- Processing of information from PTC thermal probes
- Monitoring of the starting time
- Protection against underloads and overcurrents during continuous operation

Extended I/O functions for integration into control systems

- 4 logic inputs, 2 logic outputs, 3 relay outputs, and 1 analog output
- Pull-apart terminal connectors
- Function for configuring a second set of motor parameters and easy-to-adapt settings
- Display of electrical values, running conditions, and operating time
- RS-485 serial link for connection to a Modbus™ system

Communication

The ATS48 soft starter can be connected directly to a Modbus system using an RJ45 connector. It communicates over the RS-485 serial link (2-wire) using the Modbus system's RTU protocol. The communication function provides access to the configuration, adjustment, control, and signalling functions of the soft starter.

The ATS48 soft starter can be connected to other buses or networks using the communication modules and accessories below.

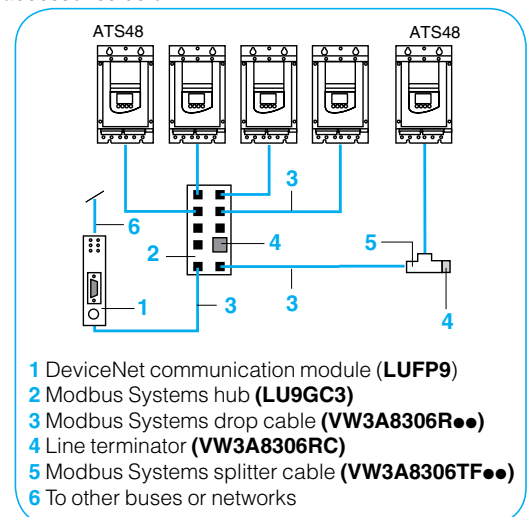

Example Altistart 48 communication network

Altistart 48

soft starters for asynchronous motors

Introduction



Remote display keypad

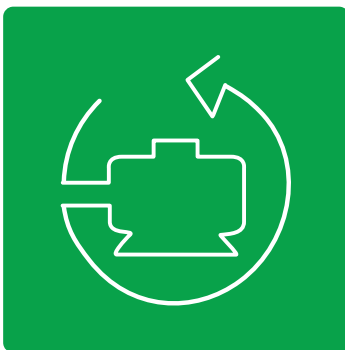

Product (continued)

Options & accessories

Remote display terminal

The Altistart 48 can be equipped with a remote display terminal. The remote keypad display can be mounted on the door of a wall-mounted or floor-standing enclosure. It has the same signalling display and configuration buttons as the keypad display integrated in the Altistart 48. A switch to lock access to the menus is located on the back of the keypad display.

- 1 Information is displayed in the form of codes or values in three 7-segment displays
- 2 ESC: Button for exiting the menus
- 3 ENT: Validation button for entering a menu or confirming the new value selected
- 4 Buttons for scrolling through the menus

SoMove setup software

SoMove™ setup software is user-friendly software for PC designed for configuring the Altistart 48. SoMove software incorporates various functions for the device setup phases, such as:

- Configuration preparation
- Start-up
- Maintenance

To facilitate setup and maintenance of devices, SoMove software can use a direct USB/RJ45 cable link **1** or a Bluetooth® wireless link **2 & 3** to connect to the motor control device and communicate directly to it.

SoMove software is also compatible with the Multi-Loader configuration tool, used for copying device configurations to multiple devices. These tools can save a significant amount of time when loading, duplicating or editing configurations on a device.



Example of SoMove setup software

Altistart 48

soft starters for asynchronous motors

Introduction

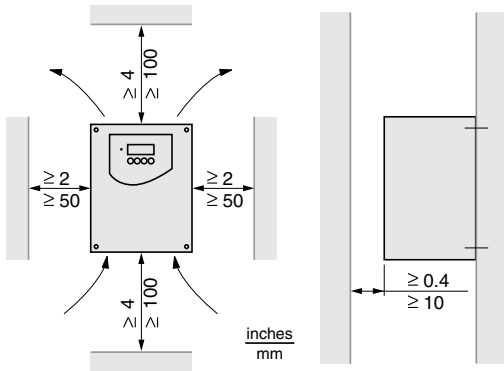

Product (continued)

Mounting recommendations

- Install the Altistart 48 vertically, within $\pm 10^\circ$.
- Do not place the Altistart 48 near sources of heat.
- Leave sufficient free space to ensure that the air required for cooling can circulate from the bottom to the top of the unit.

Note: The IP 00 version of the Altistart 48 must be fitted with a protective cover to protect personnel against electrical contact. Protective covers are available for the ATS48C14Y to ATS48C32Y. They should be ordered separately.

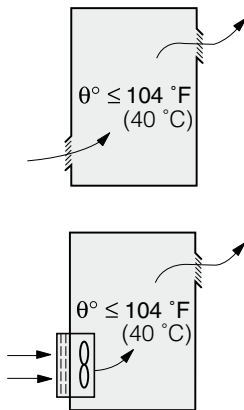

Mounting in an enclosure

The following recommendations are for mounting an Altistart 48 in a metal wall-mounted or floor-standing enclosure with degree of protection Type 1 (IP 23) or Type 12 (IP 54).

- Observe the mounting recommendations above.
- To ensure proper air circulation in the soft starter:
 - Fit ventilation grilles
 - Ensure that there is sufficient ventilation. If not, install forced ventilation with a filter. The openings and/or fans must provide a flow rate at least equal to that of the soft starter fans (see the table below)
- Use special filters with Type 12 (IP 54) protection.

Fan Flow Rate Depending On The Soft Starter Rating

ATS48 Soft Start	Flow rate CFM	Flow rate m ³ /hour
ATS48D32Y and D38Y	24	14
ATS48D47Y	48	28
ATS48D62Y to C11Y	146	86
ATS48C14Y and C17Y	235	138
ATS48C21Y to C32Y	476	280
ATS48C41Y to C66Y	1020	600
ATS48C29Y to M12Y	2040	1200

For non-ventilated Altistart 48 soft starters (ATS48D17Y and 48D22Y) in metal wall-mounted or floor-standing enclosures with Type 12 (IP 54) degree of protection, install no more than 2 in. (50 mm) below the soft starter to circulate the air inside the enclosure in order to avoid hot spots.

Altistart 48

soft starters for asynchronous motors

Functions

Adjustment

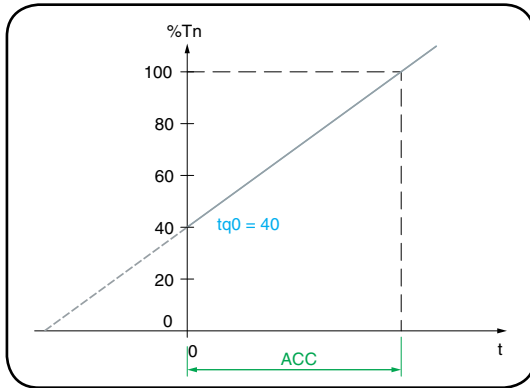

Acceleration ramp during time (**ACC**) with initial starting torque $tq_0 = 40\%$ of the nominal motor torque

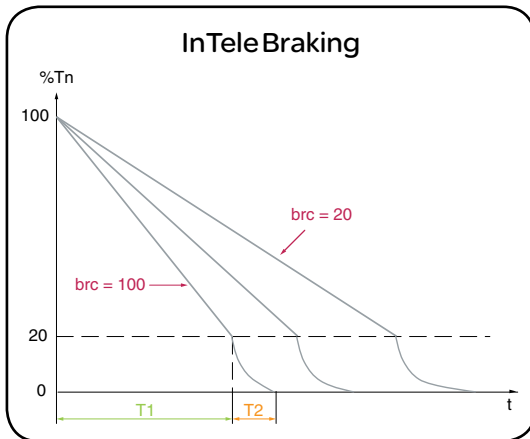

InTele braking stops for different braking torque levels (**brc**)

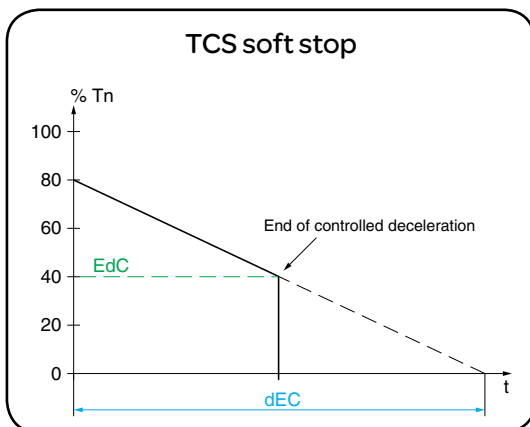

Decelerated stop by torque control during time (**dEC**) with threshold (**EdC**) for changing to freewheel stop mode $EdC = 40\%$ of nominal motor torque

Functions

Adjustment functions

Nominal motor current (maximum permanent current)

The nominal current of the soft starter can be adapted to the nominal motor current indicated on the nameplate.

Adjustment range: 0.4 to 1.3 times the soft starter nominal current.

Limiting current

The maximum starting current can be adjusted.

Adjustment range: 150% to 700% of the nominal motor current. Limited to 500% of the maximum permanent current defined for the soft starter rating.

Acceleration ramp time

During the starting phase, the ATS48 soft starter applies a torque ramp to the motor. The ramp time (**ACC**) corresponds to the time it takes the ramp to reach the nominal torque (starting at 0).

Adjustment range: 1 to 60 s.

Initial starting torque

The initial torque (**tq0**) applied to the motor can be used to instantly overcome any resistive starting torque.

Adjustment range: 0 to 100% of the nominal motor torque.

Selection of the type of stop

Three types of stop are available:

■ InTele braking

- The braking torque level (**brc**) can be adjusted. The dynamic braking time (**T1**) corresponds to the time taken to decelerate from 100% to 20% of the nominal motor speed. To improve braking at the end of deceleration, the soft starter injects a DC current for an adjustable period of time (**T2**). It produces less motor heating than traditional DC injection braking.

■ TCS soft stop (pump application)

- This type of stop enables a centrifugal pump to decelerate gradually on a ramp in order to avoid a sudden stop. It can be used to dampen the hydraulic transient in order to significantly reduce pressure surges. The deceleration ramp time (**dEC**) can be adjusted. During deceleration, the pump flow rate decreases and becomes negligible at a certain speed. To continue to decelerate would serve no purpose. A torque threshold (**EdC**) can be set at which the motor will change to freewheel stop mode, avoiding the unnecessary heating of the motor and the pump.

■ Freewheel motor stop (default setting)

Functions (continued)

Protection functions

Calculated motor thermal protection

The soft starter continuously calculates the temperature rise of the motor based on the nominal current and the actual current absorbed. In order to adapt the ATS48 soft starter to individual motors and applications, several protection classes are offered in accordance with standard IEC 60947-4-2: Class 30, Class 25, Class 20 (severe duty application), Class 15, Class 10 (standard duty application), Class 10 A, sub-class 2.

Different protection classes are defined for the starting capacities of the motor

- Cold start without detected thermal fault (corresponding to a stabilized motor thermal state, motor switched off)
- Warm start without detected thermal fault (corresponding to a stabilized motor thermal state, at nominal power)

The motor thermal protection function can be disabled.

After the motor has stopped or the soft starter has been switched off, the thermal state is calculated even if the control circuit is not energized. The ATS48 soft starter's thermal control prevents the motor from restarting if the temperature rise is too high. If special motors are used which do not have thermal protection, provide external thermal protection via probes or thermal overload relays.

The soft starter is factory preset to Class 10.

The tripping curves to the left are based on the relationship between the starting current (I_s) and the adjustable nominal motor current (I_n).

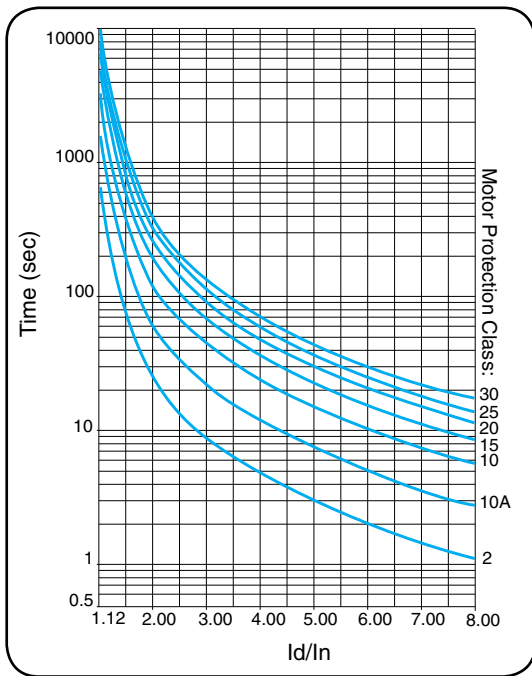

Motor thermal protection curves (cold)

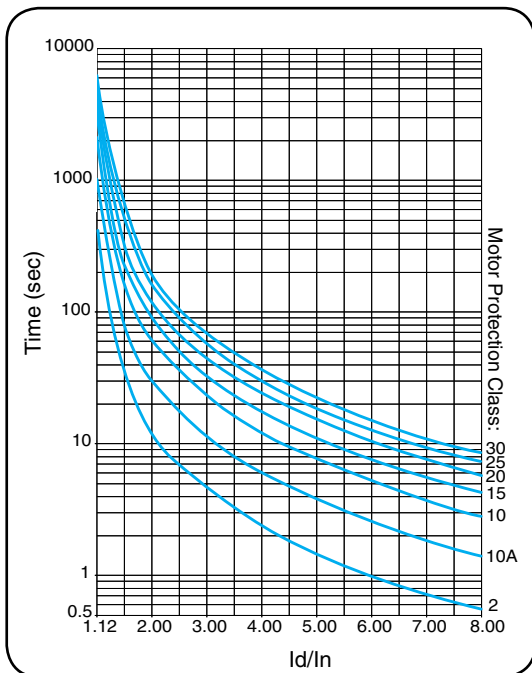

Motor thermal protection curves (warm)

Trip time (cold)

Trip time for a standard duty application (class 10)			Trip time for a severe duty application (class 20)		
$I_s = 3 I_n$	$I_s = 4 I_n$	$I_s = 5 I_n$	$I_s = 3.5 I_n$	$I_s = 4 I_n$	$I_s = 5 I_n$
46 sec	23 sec	15 sec	63 sec	48 sec	29 sec

Trip time (warm)

Trip time for a standard duty application (class 10)			Trip time for a severe duty application (class 20)		
$I_s = 3 I_n$	$I_s = 4 I_n$	$I_s = 5 I_n$	$I_s = 3.5 I_n$	$I_s = 4 I_n$	$I_s = 5 I_n$
23 sec	12 sec	7.5 sec	32 sec	25 sec	15 sec

Reset motor thermal state

Activating this function resets the motor thermal state calculated by the ATS48 to zero.

Motor thermal protection with PTC probes

PTC probes are integrated into the soft starter, thus avoiding the necessity of an external thermal protection device. The "PTC probe thermal overshoot" fault alarm can be indicated using a configurable logic output or displayed via the serial link. This function can be disabled.

Note: The PTC probe protection and calculated motor thermal protection functions are independent and can be active simultaneously.

Soft starter thermal protection

The soft starter is protected against thermal overloads by an analog thermal probe.

The cooling fan on the soft starter is switched on as soon as the heatsink temperature reaches 122 °F (50 °C). It is switched off when the temperature returns to 104 °F (40 °C).

Functions (continued)

Protection functions (continued)

Motor underload protection

The soft starter detects a motor underload if the motor torque falls below a preset torque threshold (**LUL**) for a specific (adjustable) period of time (**tUL**).

The motor underload threshold can be set between 20% and 100% of the nominal motor torque. The permissible underload duration can be set between 1 and 60 s. The detection function (**ULL**) can trigger an alarm or a detected fault. The detection function can be disabled. The "motor underload detected" alarm can be indicated by a configurable logic output or displayed via the serial link. The "motor underload detected" fault (**ULF**) locks the soft starter and can be displayed via the serial link.

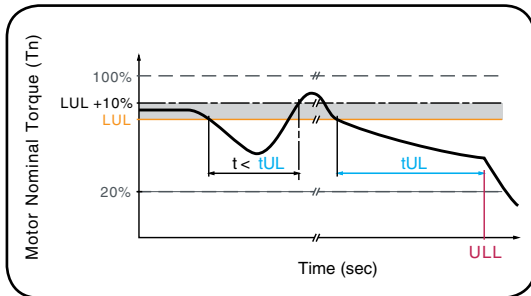

Motor underload detection (**ULL**)

Excessive acceleration time protection

This protection function can be used to detect a start which takes place in adverse conditions. Examples of such conditions include a locked rotor or a motor unable to reach its nominal rotation speed. If the start duration is longer than the set value (between 10 and 999 s), the soft starter enters detected fault mode. The function can be disabled.

Current overload protection

The soft starter detects a current overload if the motor current exceeds a preset overcurrent threshold (**LOC**) for a specific adjustable period of time (**tOL**). The overcurrent threshold can be set between 50% and 300% of the nominal motor current. The permissible overcurrent duration can be set between 0.1 and 60 s. This function is only active in steady state. The detection function (**OIL**) can trigger an alarm or a detected fault. It can also be disabled. The "current overload detected" alarm can be indicated by a configurable logic output or displayed via the serial link. The "current overload detected" fault (**OLC**) locks the soft starter and can be displayed via the serial link.

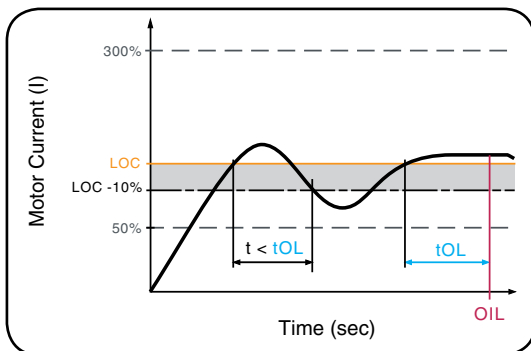

Motor overcurrent detection (**OIL**)

Protection against line phase inversion

This function can be used to detect the direction of rotation of the motor phases and, if it is enabled, to indicate a detected fault when the direction of rotation is reversed.

Time before restarting

This function can be used to avoid several consecutive starts which may cause:

- Thermal overheating of the application
- A detected thermal fault, which may require maintenance work
- Overcurrents (if direction of rotation is reversed) or repeats (run/stop command)

After a stop command, the motor can only restart after the preset time delay has elapsed. The motor is restarted when the time delay has elapsed if a run command is still valid or if a new run command is sent.

Adjustment range: 0 to 999 s.

Motor phase loss detection

The function is used to adjust the sensitivity of the protection function to detect a loss of current or a low current in one of the three motor phases for at least 0.5 s or in all three motor phases for at least 0.2 s. The value of the minimum current level can be set between 5% and 10% of the soft starter nominal current.

Automatic restart

This function permits up to six restart attempts after locking on a detected fault at intervals of 60 s if the cause of the detected fault has been removed and if the run commands are still present. After the sixth attempt, the soft starter remains locked and the detected fault must be reset before a restart is permitted.

If the function is active, the fault relay remains activated if line phase loss, motor phase loss, or line frequency out of tolerance faults are detected. This function can only be used in 2-wire control.

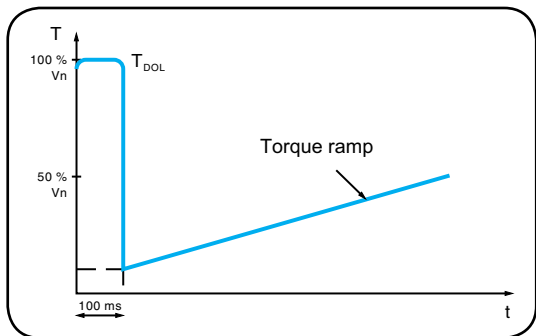

Application of a voltage boost equal to 100% of the nominal motor voltage

Functions (continued)

Advanced adjustment functions

Torque limit

Used primarily for high inertia and constant torque conveyor applications, this function restricts the torque ramp reference to the preset value. For example, the function can be used to limit the torque to a constant value throughout the starting period.

Adjustment range: 10% to 200% of the nominal motor torque.

Voltage boost level

This function can be used to avoid any "starting" torque (phenomenon caused by friction on stopping or by mechanical play). When a run command is sent, the soft starter applies a fixed voltage to the motor for a limited period of time before starting. The function can be disabled. The voltage setting value varies between 50% and 100% of the nominal motor voltage.

Test on low power motor

This function can be used to test a starter on a motor with a much lower power than the soft starter. It can be used, for example, to check the electrical wiring of a device. The function is automatically cancelled when the soft starter is switched off. The next time the soft starter is switched on, the soft starter returns to its initial configuration.

Activation of the cascade function

This function can be used to start and decelerate several cascaded motors with a single soft starter. In order to gain maximum benefit from torque control, it is advisable to use motors with power ratings between 0.5 and 1 times the power of the soft starter.

Line frequency

The following frequencies can be selected for this function:

- 50 Hz. The frequency fault monitoring tolerance is $\pm 20\%$.
- 60 Hz. The frequency fault monitoring tolerance is $\pm 20\%$.
- Automatic detection of the line frequency by the soft starter. The frequency fault monitoring tolerance is $\pm 6\%$.

50 Hz and 60 Hz are recommended if the power supply is provided by an emergency standby generator set, given their high tolerance.

Reset kW/h or the operating time

Sets the value of the power in kW/h or the operating time value to 0. The calculation of the values is updated once the reset command has been sent.

Return to factory settings

This function can be used to reset each setting to its initial value (soft starter factory settings, see page 13).

Functions (continued)

2nd motor adjustment functions

In order to access the 2nd motor adjustment functions, one logic input must be assigned to the second set of motor parameters function. The adjustment functions and ranges are identical for both sets of motor parameters.

The settings are as follows (see page 9):

- Nominal motor current
- Limiting current
- Acceleration ramp time
- Initial starting torque
- Deceleration ramp time
- Threshold for changing to freewheel stop mode at the end of deceleration
- Maximum torque limit

Communication functions

The ATS48 soft starter is supplied with an RS-485 multidrop serial link with Modbus systems protocol as standard. The serial link is configured in the Communication menu using:

- The address of the soft starter (0 to 31)
- The communication speed (4800, 9600, or 19200 bps)
- The format of the communication data. The following formats can be selected:
 - 8 data bits, odd parity, 1 stop bit
 - 8 data bits, even parity, 1 stop bit
 - 8 data bits, no parity, 1 stop bit
 - 8 data bits, no parity, 2 stop bits
- The time-out (1 to 60 sec)

Altistart 48 Default Settings

Function	Default setting
Nominal motor current	(depends on the soft starter rating)
Limiting current	400%
Acceleration ramp time	15 sec
Initial starting torque	20%
Selection of the type of stop	Freewheel stop
Motor thermal protection	Class 10
Time before restarting	2 sec
Motor phase loss threshold	10%
Line frequency	Automatic
RUN and STOP logic inputs	2-wire or 3-wire control via wiring
Logic input LI3	Forced freewheel stop
Logic input LI4	Local mode control (serial link disabled)
Logic output LO1	Thermal motor alarm
Logic output LO2	Motor powered
Relay output R1	Fault relay
Relay output R3	Motor powered
Analog output	Motor current

Functions (continued)

Application monitoring functions

The monitoring functions provide the following information:

- **Power factor:** displayed between 0.00 and 1.00
- **Motor thermal state:** 100% corresponds to the thermal state of the motor consuming the set nominal current
- **Motor current:** displayed in amperes between 0 and 999 A and in kA between 1000 and 9999 A
- **Operating time:** corresponding to the total number of soft starter operating hours during heating, acceleration, steady state, deceleration, braking, and continuous bypass operation. It is displayed in hours between 0 and 999 hours and in kilo hours between 1000 and 65536 hours. The active power is displayed between 0 and 255%, where 100% corresponds to the power at the set nominal current and at full voltage.
- **Motor torque:** displayed between 0 and 255%, where 100% corresponds to the nominal torque.
- **Active power consumed:** displayed in HP. The line voltage value must be configured. The accuracy of this setting depends on the error between the voltage configured and the actual voltage.
- **The following soft starter states are shown in the display of the current state:**
 - Soft starter without a run command and with no power supplied
 - Soft starter without a run command and with power supplied
 - Acceleration/deceleration in progress
 - Steady state operation
 - Braking in progress
 - Soft starter in current limiting mode
 - Starting time delay not elapsed
- **Last fault condition**
- **Phase rotation direction:** Displays the direction of rotation (direct or indirect).
- **Keypad display locking code**
 - An access code can be used to protect access to the soft starter's adjustment and configuration parameters. Only the monitoring parameters are accessible when the adjustment and configuration parameters are locked out.

Logic input application functions

The Altistart 48 has 4 logic inputs:

- 2 logic inputs (RUN and STOP) are reserved for run/stop commands which can be sent in the form of maintained contacts or as pulsed contacts.
 - **2-wire control:** Starting and stopping are controlled by a single logic input. State 1 of the logic input controls starting and state 0 controls stopping.
 - **3-wire control:** Starting and stopping are controlled by 2 separate logic inputs. A stop is obtained on opening (state 0) the STOP input. The pulse on the RUN input is stored until the stop input opens.
- 2 logic inputs (LI3 and LI4) can be configured with the following functions:
 - **Freewheel stop:** When combined with a braked stop or decelerated stop command, activating the logic input will stop the motor in freewheel mode.
 - **External detected fault:** Enables the soft starter to detect an external, customer defined fault event (such as level or pressure). When the contact is open, the soft starter enters detected fault mode.
 - **Force to local control mode:** When the soft starter is connected to a serial link, this function can be used to change from line mode (control via serial link) to local mode (control via the keypad display).
 - **Reset motor thermal fault:** Enables the motor thermal fault to be reset remotely.
 - **Activation of the cascade function:** With this function active, motor thermal protection is disabled and relay R1 is configured as the fault isolation relay. This function can be used to start and decelerate several motors one after the other with a single soft starter.
 - **Reset all fault events:** Enables all fault events to be reset remotely.
 - **Second set of motor parameters:** Enables a second set of parameters to be selected to start and decelerate two different motors with a single soft starter.

Functions (continued)

Logic output application functions

The soft starter has 2 logic outputs (LO1 and LO2) which, depending on their configuration, can be used for remote indication of the following states or events:

- **Motor thermal alarm:** The motor thermal state has exceeded the alarm threshold. This alarm can be used, for example, to avoid starting a motor if the thermal reserve is insufficient.
- **Motor powered:** Indicates that there may be current in the motor.
- **Motor overcurrent alarm:** The motor current is higher than the set threshold.
- **Motor underload alarm:** The motor torque is lower than the set threshold.
- **Motor PTC probe alarm:** The thermal state monitored by the PTC motor probe has been exceeded.
- **Second set of motor parameters activated**

Relay and analog output application functions

The soft starter has 3 relays, 2 of which are configurable:

- Relay R1 application functions

Relay R1 can be configured as follows:

- **Fault relay:** Relay R1 is activated when the soft starter is powered and there are no fault conditions. It is deactivated when a fault condition occurs and the motor switches to freewheel mode.
- **Isolating relay:** The contact of relay R1 closes when a run command is sent and re-opens when a stop command is sent, at the end of deceleration on a decelerated stop or in the event of a fault condition. The line contactor is deactivated and the motor is isolated from the line supply.

- **End of starting relay R2:** Cannot be configured. The end of starting relay controls the bypass contactor on the soft starter. It is activated when the motor completes the starting phase. It is deactivated when a stop command is sent and in the event of a fault condition. The soft starter regains control when a braking or deceleration command is sent.

- Relay R3 application functions

Relay R3 is configured to indicate the same states or events as logic outputs LO1 or LO2.

- Analog current output AO application function:
 - Analog output AO provides an image of the following values: motor current, motor torque, motor thermal state, power factor, active power.
 - The following settings are associated with the analog output:
 - The type of signal supplied: 0-20 mA or 4-20 mA
 - The scale setting of the signal. The function associates the maximum amplitude of the analog output (20 mA) with a percentage of the nominal value of the parameter, which can be set between 50% and 500%.

Function compatibility table

Functions	Decelerating stop	InTele braking stop	Forced freewheel stop	Thermal protection	Motor phase loss detection	Tests on low power motor	Cascaded motors
Decelerating stop	N/A	No	Yes	Yes	Yes	Yes	Yes
InTele braking stop	No	N/A	Yes	Yes	Yes	Yes	Yes
Forced freewheel stop	Yes	Yes	N/A	Yes	Yes	Yes	No
Thermal protection	Yes	Yes	Yes	N/A	N/A	Yes	No
Motor phase loss detection	Yes	Yes	Yes	N/A	N/A	Yes	N/A
Tests on low power motor	Yes	Yes	Yes	Yes	Yes	N/A	No
Cascaded motors	Yes	Yes	No	No	N/A	No	N/A

Altistart 48

soft starters for asynchronous motors

Specifications

Environmental

Environmental specifications

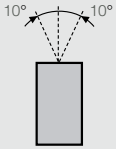
Type of starter		ATS48●●●Y
Conforming to standards		The ATS48 soft starters have been developed and performance tested in accordance with international standards, in particular with the starter product standard EN/IEC 60947-4-2.
Electromagnetic compatibility EMC ⁽¹⁾	Conducted and radiated emissions	IEC 60947-4-2, class A on all starters <input type="checkbox"/> Class B on starters up to 170 A: ATS48D17●...48C17●. (Must bypass at end of starting)
	Electrostatic discharge	kV IEC 61000-4-2 level 3, Test levels: <input type="checkbox"/> By contact: 6 kV <input type="checkbox"/> In the air: 8 kV
	Immunity to radiated radio-frequency electromagnetic field	V/m IEC 61000-4-3 level 3, Test levels: <input type="checkbox"/> 10 V/m
	Immunity to electrical transients	kV IEC 61000-4-4 level 4, Test levels: <input type="checkbox"/> Power supply cables: 4 kV <input type="checkbox"/> Control cables: 2 kV
	Surge immunity	kV IEC 61000-4-5 level 3, Test levels: <input type="checkbox"/> Phase/phase: 1 kV <input type="checkbox"/> Phase/ground: 2 kV
	Damped oscillating waves	kV, Hz IEC 61000-4-12 level 3, Test levels: <input type="checkbox"/> 1 kV - 1 M Hz
CE marking		CE marking in accordance with the harmonized standard EN/IEC 60947-4-2.
Product certifications		CCC, CSA, C-Tick, DNV, GOST, NOM 117, SEPRO, TCF, and UL
Degree of protection	For ATS48D17Y...48C11Y	IP 20 (IP 00 if no connections)
	For ATS48C14Y...48M12Y ⁽²⁾	IP 00
Soft starter noise level⁽³⁾	Soft starters ATS48D32Y to D47Y	dBA 52 dBA
	Soft starters ATS48D62Y to C11Y	dBA 58 dBA
	Soft starters ATS48C14Y to C17Y	dBA 50 dBA
	Soft starters ATS48C21Y to C32Y	dBA 54 dBA
	Soft starters ATS48C41Y to C66Y	dBA 55 dBA
	Soft starters ATS48C79Y to M12Y	dBA 60 dBA
Fans	For ATS48D17Y and D22Y	Natural convection
	For ATS48D32Y...M12Y	Forced convection. The fans are activated automatically when a temperature threshold is reached. For flow rate, see page 8.
Maximum ambient pollution		Level 3 Conforming to IEC/EN 60664-1
Vibration resistance		1.5 mm from 2 to 13 Hz, 1 gn from 13 to 200 Hz Conforming to IEC/EN 60068-2-6
Shock resistance		15 gn for 11 ms Conforming to IEC 60068-2-27
Relative humidity		95% non-condensing, no dripping water Conforming to IEC/EN 60068-2-3
Ambient air temperature around the device	Storage	°F -13...158 °F (-25...70 °C) conforming to IEC/EN 60947-4-2
	Operation	°F 14 °F (-10 °C) to 104 °F (40 °C) without derating Up to 140 °F (60 °C) with current derating of 2% per degree above 104°F (40 °C) 14 to 122 °F (-10 to 50 °C) with user supplied shorting/bypass contactor
Maximum operating altitude		3300 ft (1000 m) without derating Above this, derate the nominal current by 2.2% per additional 330 ft (100 m) to a maximum of 6600 ft (2000 m)
Operating position Maximum permanent angle in relation to the normal vertical mounting position		

(1) The soft starters conform to IEC 60947-4-2 (EMC). This standard ensures a level of immunity for products and a level of emitted interference. In steady state, the interference emitted is below that required by the standard.

(2) Protective covers can be fitted to the power terminals of ATS48C14Y to C32Y soft starters. ATS48C41Y to 48M12Y soft starters have protection on the front panel and on the sides.

(3) Soft starters located 3 ft. (1 m) away. The noise levels may change depending on the characteristics of the fans.

Altistart 48

soft starters for asynchronous motors

Specifications

Electrical

Electrical specifications

Operating category		AC-53a Conforming to IEC 60947-4-2
Three-phase supply voltage		V 208 V -15% to 690 V +10%
Input frequency		Hz 50/60 Hz \pm 5% (automatic), 50 Hz or 60 Hz \pm 20% (must be set)
Nominal soft starter current		A 17 A to 1200 A
SCRs		PIV 1800 PIV
Motor power		HP 2 to 1200 HP (3 to 900 kW)
Voltage indicated on the motor nameplate		V 208 V to 690 V
Soft starter control circuit supply voltage		V 110 V -15% to 230 V +10%, 50/60 Hz
Maximum control circuit consumption (with fans operating)	For ATS48D17Y...C17Y	W 30 W
	For ATS48C21Y...C32Y	W 50 W
	For ATS48C41Y...M12Y	W 80 W
Relay output (2 configurable outputs)		3 relay outputs (R1, R2, R3), normally open contacts 1 N.O. Minimum switching capacity: 10 mA for 6 Vdc. Maximum switching capacity on inductive load: 1.8 A for 230 Vac and 30 Vdc (power factor= 0.5 and L/R=20 ms). Maximum nominal operating voltage is 400 Vac. Factory setting: R1 assigned as the fault relay (configurable) R2 assigned as the end of starting relay to control the soft start bypass relay R3 assigned as motor powered (configurable)
Logic inputs LI (2 configurable inputs)		4 logic inputs: Stop, Run, LI3, LI4; Impedance: 4.3 k Ω , isolated + 24 V input (maximum 30 V) I max. 8 mA State 0 if V < 5 V, State 1 if V > 11 V
Internal source available		One 24 V output, isolated and protected against short-circuits and overloads. Accuracy \pm 25%. Max. current 200 mA.
Logic outputs LO (configurable)		2 logic outputs LO1 and LO2 with 0 V common, compatible with level 1 PLC, according to standard IEC 65A-68. + 24 V input (minimum: +12 V, maximum: +30 V) to LO+ Maximum LO output current: 200 mA if external 24 V power supply is used
Analog output AO (configurable)		Current output 0-20 mA or 4-20 mA Maximum load impedance: 500 Ω Accuracy \pm 5% of the maximum value
Input for PTC probe		Total resistance of probe circuit 750 Ω at 25 $^{\circ}$ C (77 $^{\circ}$ F), according to IEC 60 738-A
Maximum I/O connection capacity		12 AWG (2.5 mm ²)
Communication		RS-485 multidrop serial link integrated in the starter, for Modbus Systems, with RJ45 connector Transmission speed: 4800, 9600 or 19200 bps Maximum number of ATS48 soft starters connected: 18 Other uses: <input type="checkbox"/> Connection to a remote keypad display <input type="checkbox"/> Connection to a PC <input type="checkbox"/> Connection to other buses and networks via communication options
Protection	Thermal	Built-in, starter and motor (calculated and/or thermal protection with PTC probes)
	Line Protection	Phase failure protection, indicated by output relay
Current settings		The nominal motor current, I _n , can be adjusted from 0.4 to 1.3 times the starter nominal current. Adjustment of the maximum starting current from 1.5 to 7 times the motor I _n , limited to 5 times the starter nominal current.
Starting mode		By torque control with starter current limited to 5 I _n maximum. Factory setting: 4 I _n for standard operation on 15 s torque ramp
Stopping mode	Freewheel stop	Freewheel stop (factory setting)
	Controlled stop on torque ramp	Programmable between 0.5 and 60 s (for pump applications)
	Braked stop	Controlled dynamically by the flux

Note:

- Power factor correction capacitors can only be used upstream of the ATS48 soft start and only powered up at the end of starting.
- The soft starter must be grounded to meet regulations concerning leakage currents (\leq 30 mA). If the installation involves several soft starts on the same supply line, each soft starter must be grounded separately.

Altistart 48

soft starters for asynchronous motors

Specifications

I/O & Control



Altistart 48 control terminals

I/O & Control specifications

The control terminals are fitted with one way plug-in connectors.

Maximum connection capacity: 2.5 mm² (12 AWG)

Maximum tightening torque: 0.4 N•m (3.5 lb•in)

ATS48●●●Y control terminals

Terminal	Function	Characteristics
CL1 CL2	ATS48 control power supply	ATS48●●●Y: 208 V to 600 V + 10% - 15%, 50/60 Hz
R1A R1C	Normally open (N/O) contact of programmable relay R1	Minimum switching capacity: ■ 10 mA for 6 V $\overline{\text{---}}$ Maximum switching capacity on inductive load (cos ϕ = 0.5 and L/R = 20 ms): ■ 1.8 A for 230 V _a and 30 V _c
R2A R2C	Normally open (N/O) contact of end of starting relay R2	
R3A R3C	Normally open (N/O) contact of programmable relay R3	
STOP	Stop starter (state 0 = stop)	4 x 24 V logic inputs with 4.3 kW impedance U _{max} = 30 V, I _{max} = 8 mA state 1: U > 11 V - I > 5 mA state 0: U < 5 V - I < 2 mA
RUN	Run starter (state 1 = run if STOP is at 1)	
LI3	Programmable input	
LI4	Programmable input	
24V	Logic input power supply	+24 V \pm 25% isolated and protected against shortcircuits and overloads. Maximum current: 200 mA
LO+	Logic output power supply	To be connected to 24 V or an external source
LO1 LO2	Programmable logic outputs	2 open collector outputs, compatible with level 1 PLC IEC 65A-68 standard ■ Power supply +24 V (min. 12 V, max. 30 V) ■ Maximum current 200 mA per output with an external source
AO1	Programmable analog output	Output can be configured as 0 - 20 mA or 4 - 20 mA ■ Accuracy \pm 5% of the maximum value ■ Maximum load impedance: 500 Ω
COM	I/O common	0 V
PTC1 PTC2	Input for PTC probes	Total resistance of probe circuit 750 W at 77 °F (25 °C) (3 x 250 W probes in series, for example)
RJ45	Connector for: ■ Remote terminal ■ PowerSuite ■ Communication bus	RS 485 Modbus

Altistart 48

soft starters for asynchronous motors

Selection Criteria

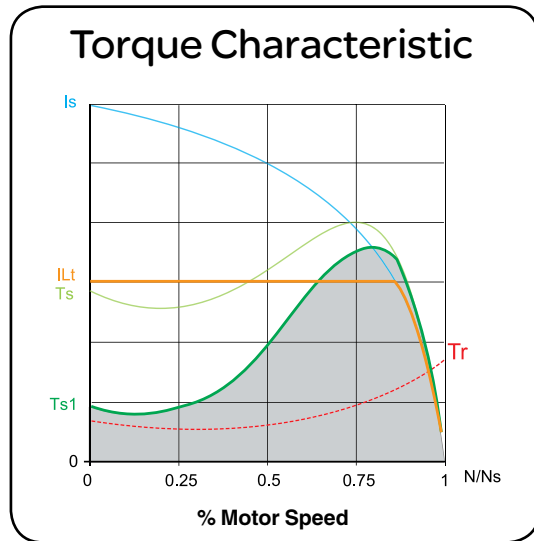

Asynchronous motor

Ts: Across the line starting torque

Is: Across the line starting current

Altistart 22

Ts1: Total torque range available with an Altistart 48, which is dependent on the current limit (**Is1**) setting.

Load

Tr: Resistive torque must always be less than the Ts1 torque, or the motor will not start.

Selection Criteria

In addition to the chosen application, the choice of starter will depend on the following main criteria:

- **AC mains voltage supply:**
 - Three-phase AC voltage: 208–690 V
- **Power and nominal current (In) indicated on the motor name plate**
- **Duty cycle**
- **Starting current capacity**

Whether an application is a standard duty or severe duty application determines the limiting values of the current and the duty cycle ratings.

Duty cycle

S1 motor duty: Duty cycle of starting followed by operation at constant load enabling the thermal stability to be reached.

S4 motor duty: Duty cycle of starting, operation at constant load, and an idle period. This cycle is characterized by a load factor.

These motor duties are described in more detail in IEC 60034-1.

Starting current capacity - Standard duty

In standard duty applications, the ATS48 soft starter is designed to provide:

- **S1 motor duty:**
 - Starting at 4 In for 23 seconds with a cold motor
 - Starting at 3 In for 46 seconds with a cold motor
- **S4 motor duty** (with a load factor of 50% and 10 starts per hour):
 - Starting at 3 In for 23 seconds
 - Starting at 4 In for 12 seconds
 - or an equivalent thermal cycle

The motor thermal protection conforms to Class 30, Class 25, Class 20 (severe duty application), Class 15, Class 10 (standard duty application), Class 10 A, and sub-class 2 motor thermal overload protection (see page 10).

Starting current capacity - Severe duty

In severe duty applications, the ATS48 soft starter is designed to provide:

- **S1 motor duty:**
 - Starting at 4 In for 48 seconds with a cold motor
 - Starting at 3 In for 90 seconds with a cold motor
- **S4 motor duty** (with a load factor of 50% and with 5 starts per hour):
 - Starting at 4 In for 23 seconds
 - or an equivalent thermal cycle

The motor thermal protection conforms to Class 30, Class 25, Class 20 (severe duty application), Class 15, Class 10 (standard duty application), Class 10 A, and sub-class 2 motor thermal overload protection (see page 10).

Selecting the soft starter

First, identify the application type and corresponding starting current on page 20. Once the application type has been identified, select the soft starter from page 22 or 23 according to the supply voltage and the motor power.

Note: If the ATS48 soft starter is installed inside an enclosure, observe the mounting and derating recommendations on page 8.

Application types

Depending on the type of machine, the applications are categorized as standard or severe duty based on the starting characteristics. Examples are given in the table below.

Standard Applications

Type of machine	Functions performed by the ATS48	Starting current (%In)	Starting time (s)
Centrifugal pump	<ul style="list-style-type: none"> Deceleration (reduction in pressure surges) Protection against underloads or inversion of the phase rotation direction 	300	5 to 15
Piston pump	<ul style="list-style-type: none"> Control of running dry and direction of rotation of the pump 	350	5 to 10
Cold compressor	<ul style="list-style-type: none"> Protection, even for special motors 	300	5 to 10
Screw compressor	<ul style="list-style-type: none"> Protection against inversion of direction of phase rotation Contact for automatic draining on stopping 	300	3 to 20
Piston compressor	<ul style="list-style-type: none"> Protection against inversion of direction of phase rotation Contact for automatic emptying on stopping 	350	5 to 10
Conveyor, transporter	<ul style="list-style-type: none"> Overload control for detecting faults or underload control for detecting breaks 	300	3 to 10
Lifting screw	<ul style="list-style-type: none"> Overload control for detecting hard spots or underload control for detecting breaks 	300	3 to 10
Drag lift	<ul style="list-style-type: none"> Overload control for detecting jamming or underload control for detecting breaks 	400	2 to 10
Lift	<ul style="list-style-type: none"> Overload control for detecting jamming or underload control for detecting breaks Constant starting with variable load 	350	5 to 10
Agitator	<ul style="list-style-type: none"> The current display indicates the density of the product 	350	5 to 20
Mixer	<ul style="list-style-type: none"> The current display indicates the density of the product 	350	5 to 10
Refiner	<ul style="list-style-type: none"> Torque control on starting and stopping 	300	5 to 30

Standard/ Severe Applications

Type of machine	Functions performed by the ATS48	Starting current (%In)	Starting time (s)
Fan	<ul style="list-style-type: none"> Detection of overloads caused by clogging or underloads (motor fan transmission broken) Braking torque on stopping 	300	10 to 40
Centrifugal compressor	<ul style="list-style-type: none"> Protection against inversion of direction of phase rotation Contact for automatic emptying on stopping 	350	10 to 40
Circular saw, band saw	<ul style="list-style-type: none"> Braking for fast stop 	300	10 to 60

Severe Applications

Type of machine	Functions performed by the ATS48	Starting current (%In)	Starting time (s)
Pulper, butchery knife	<ul style="list-style-type: none"> Torque control on starting 	400	3 to 10
Grinder	<ul style="list-style-type: none"> Braking to limit vibrations during stopping, overload control to detect jamming 	450	5 to 60
Crusher	<ul style="list-style-type: none"> Braking to limit vibrations during stopping, overload control to detect jamming 	400	10 to 40
Press	<ul style="list-style-type: none"> Braking to increase the number of cycles 	400	20 to 60

Special uses

Additional criteria can influence the selection of the ATS48 soft starter:

Shorting/Bypass Contactor

Refer to the recommended wiring diagrams on pages 32-34.

The soft starter can be bypassed by a contactor at the end of starting (to limit the heat dissipated by the soft starter). The shorting/bypass contactor is controlled by the soft starter and the current measurements. Thermal protection remains active when the soft starter is bypassed.

Multiple Motors

Motors may be connected in parallel provided that the power limit of the soft starter is not exceeded (the sum of the motor currents must not exceed the nominal current of the soft starter selected depending on the type of application). Individual thermal protection is required for each motor.

Brush Motor

The ATS48 soft starter can operate with a bypassed stator resistance motor or with a resistance lug. The starting torque is modified in accordance with the rotor resistance. If necessary, maintain a low resistance in order to obtain the required torque to overcome the resistive torque on starting. A bypassed brush motor has a very low starting torque. A high stator current is required to obtain the sufficient starting torque.

Oversize the soft starter so that the value of the limiting current is 7 times that of the nominal current.

NOTE: Ensure that the starting torque of the motor, equal to 7 times the nominal current, is greater than the resistive torque.

NOTE: The ATS48 soft starter torque control enables excellent soft starting despite the limiting current being 7 times the nominal current required to start the motor.

2-Speed Motor

The ATS48 soft starter can operate with a 2-speed motor. A motor demagnetization period must elapse before changing from low speed to high speed in order to avoid antiphase between the line supply and the motor, which would generate very high currents.

Select the soft starter using the three main criteria, see pages 19-21.

Long Motor Cable Lengths

Very long motor cables cause voltage drops due to the resistance of the cable. If the voltage drop is significant, it could affect the current consumption and the available torque. This criteria must be taken into account when selecting the motor and the soft starter.

Miscellaneous Application Precautions

Do not use the ATS48 soft starter upstream of loads other than motors (for example transformer and resistor type loads).

Do not connect power factor correction capacitors to the terminals of a motor controlled by an Altistart 48.

Altistart 48

soft starters for asynchronous motors

Selection Tables

Normal Duty Applications

Normal duty applications, 208...690 V supply

Motor												Soft start - soft stop unit, 208...690 V (+ 10% - 15%), 50/60 Hz							
Power indicated on rating plate												Maximum permanent current in class 10 In	Soft starter rated current IcL	Part number	Frame size	Weight			
208 V		230 V		440 V		460 V		500 V		575 V						690 V		lbs	kg
HP	kW	HP	kW	HP	kW	HP	kW	HP	kW	HP	kW	HP	kW	A	A				
3	2.2	5	4	10	7.5	10	7.5	-	9	15	11	20	15	17	17	ATS48D17Y	A	10.8	4.9
5	4	7.5	5.5	15	11	15	11	15	11	20	15	25	18.5	22	22	ATS48D22Y	A	10.8	4.9
7.5	5.5	10	7.5	20	15	20	15	25	18.5	25	18.5	30	22	32	32	ATS48D32Y	A	10.8	4.9
10	7.5	-	-	25	18.5	25	18.5	30	22	30	22	40	30	38	38	ATS48D38Y	A	10.8	4.9
-	-	15	11	30	22	30	22	40	30	40	30	50	37	47	47	ATS48D47Y	A	10.8	4.9
15	11	20	15	40	30	40	30	50	37	50	37	60	45	62	62	ATS48D62Y	B	18.3	8.3
20	15	25	18.5	50	37	50	37	60	45	60	45	75	55	75	75	ATS48D75Y	B	18.3	8.3
25	18.5	30	22	60	45	60	45	75	55	75	55	100	75	88	88	ATS48D88Y	B	18.3	8.3
30	22	40	30	75	55	75	55	100	75	100	75	125	90	110	110	ATS48C11Y	B	18.3	8.3
40	30	50	37	100	75	100	70	125	90	125	90	150	110	140	140	ATS48C14Y	C	27.3	12.4
50	37	60	45	125	90	125	90	150	110	150	110	200	160	170	170	ATS48C17Y	C	27.3	12.4
60	45	75	55	150	110	150	110	-	132	200	160	-	200	210	210	ATS48C21Y	D	40.1	18.2
75	55	100	70	-	132	200	160	200	160	250	-	350	250	250	250	ATS48C25Y	D	40.1	18.2
100	70	125	90	200	160	250	-	300	220	300	220	400	315	320	320	ATS48C32Y	D	40.1	18.2
125	90	150	110	300	220	300	220	350	250	350	250	500	400	410	410	ATS48C41Y	E	113.3	51.4
150	110	-	-	350	250	350	250	400	315	400	315	700	500	480	480	ATS48C48Y	E	113.3	51.4
-	-	200	160	450	355	400	315	500	400	500	400	-	560	590	590	ATS48C59Y	E	113.3	51.4
200	160	250	-	500	400	500	400	-	-	600	450	850	630	660	660	ATS48C66Y	E	113.3	51.4
250	-	300	220	-	500	600	-	700	500	800	600	-	710	790	790	ATS48C79Y	F	253.5	115
350	250	350	250	850	630	800	600	850	630	1000	750	1200	900	1000	1000	ATS48M10Y	F	253.5	115
400	315	450	355	-	710	1000	750	-	800	1200	900	-	-	1200	1200	ATS48M12Y	F	253.5	115

(1) The nominal motor current In must not exceed the maximum permanent current in class 10



Altistart 48

soft starters for asynchronous motors

Specifications

Heavy Duty Applications

Heavy duty applications, 208...690 V supply

Motor										Soft start - soft stop unit, 208...690 V (+ 10% - 15%), 50/60 Hz									
Power indicated on rating plate										Maximum permanent current in class 10 I_n	Soft starter rated current I_{cL}	Part number	Frame size	Weight					
208 V		230 V		440 V		460 V		500 V						575 V		690 V		lbs	kg
HP	kW	HP	kW	HP	kW	HP	kW	HP	kW	HP	kW	HP	kW	A	A				
2	-	3	2.2	7.5	5.5	7.5	5.5	10	7.5	10	7.5	15	11	12	17	ATS48D17Y	A	10.8	4.9
3	2.2	5	4	10	7.5	10	7.5	-	9	15	11	20	15	17	22	ATS48D22Y	A	10.8	4.9
5	4	7.5	5.5	15	11	15	11	15	11	20	15	25	18.5	22	32	ATS48D32Y	A	10.8	4.9
7.5	5.5	10	7.5	20	15	20	15	25	18.5	25	18.5	30	22	32	38	ATS48D38Y	A	10.8	4.9
10	7.5	-	-	25	18.5	25	18.5	30	22	30	22	40	30	38	47	ATS48D47Y	A	10.8	4.9
-	-	15	11	30	22	30	22	40	30	40	30	50	37	47	62	ATS48D62Y	B	18.3	8.3
15	11	20	15	40	30	40	30	50	37	50	37	60	45	62	75	ATS48D75Y	B	18.3	8.3
20	15	25	18.5	50	37	50	37	60	45	60	45	75	55	75	88	ATS48D88Y	B	18.3	8.3
25	18.5	30	22	60	45	60	45	75	55	75	55	100	75	88	110	ATS48C11Y	B	18.3	8.3
30	22	40	30	75	55	75	55	100	75	100	75	125	90	110	140	ATS48C14Y	C	27.3	12.4
40	30	50	37	100	75	100	75	125	90	125	90	150	110	140	170	ATS48C17Y	C	27.3	12.4
50	37	60	45	125	90	125	90	150	110	150	110	200	160	170	210	ATS48C21Y	D	40.1	18.2
60	45	75	55	150	110	150	110	-	132	200	160	-	200	210	250	ATS48C25Y	D	40.1	18.2
75	55	100	75	-	132	200	160	200	160	250	-	350	250	250	320	ATS48C32Y	D	40.1	18.2
100	75	125	90	200	160	250	-	300	220	300	220	400	315	320	410	ATS48C41Y	E	113.3	51.4
125	90	150	110	300	220	300	220	350	250	350	250	500	400	410	480	ATS48C48Y	E	113.3	51.4
150	110	-	-	350	250	350	250	400	315	400	315	700	500	480	590	ATS48C59Y	E	113.3	51.4
-	-	200	160	-	355	400	-	500	400	500	400	-	560	590	660	ATS48C66Y	E	113.3	51.4
200	160	250	-	500	400	500	400	-	-	600	450	850	630	660	790	ATS48C79Y	F	253.5	115
250	-	300	220	-	500	600	-	700	500	800	600	-	710	790	1000	ATS48M10Y	F	253.5	115
350	250	350	250	-	630	800	-	850	630	1000	750	1200	900	1000	1200	ATS48M12Y	F	253.5	115



Altistart 48

soft starters for asynchronous motors

Dimensions

Frame Size A

Dimensions

Frame size	ATS48 unit	(W x D x H)	
		in	mm
A	ATS48D17Y... ATS48D47Y	6.3 x 7.5 x 10.8	160 x 190 x 275

Frame size A

Front view

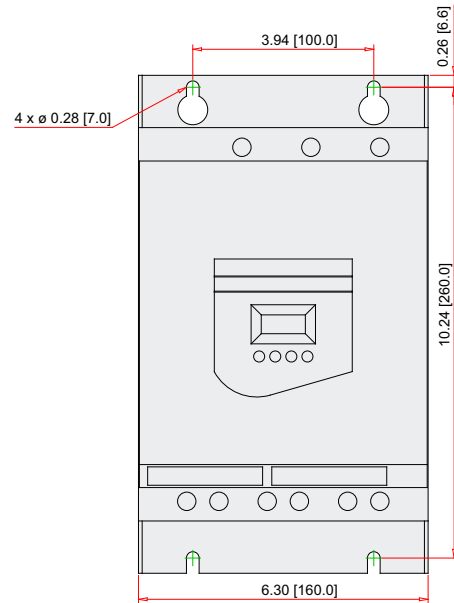

A



ATS48D17Y...
ATS48D47Y

Side view

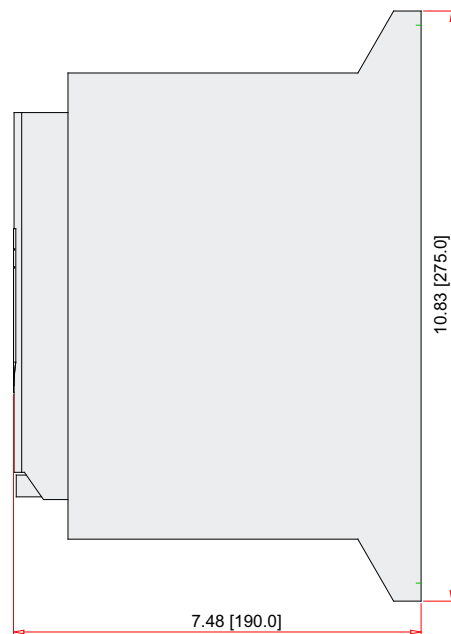

Altistart 48

soft starters for asynchronous motors

Dimensions

Frame Size B

Dimensions

Frame size	ATS48 unit	(W x D x H)	
		in	mm
B	ATS48D62Y... ATS48C11Y	7.5 x 9.3 x 11.4	190 x 235 x 290

Frame size B

Front view



ATS48D62Y...
ATS48C11Y

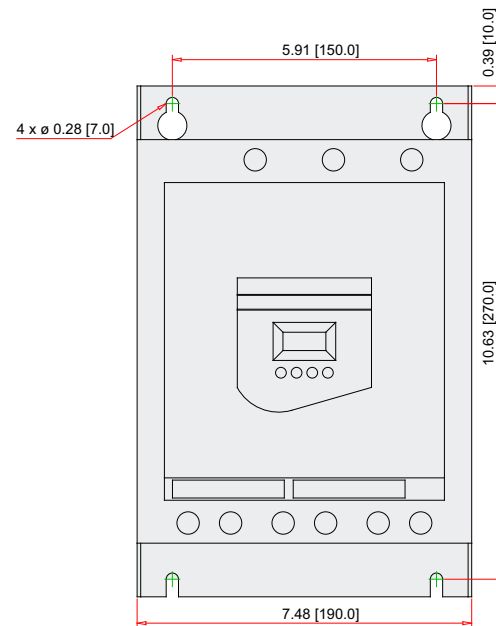

Side view

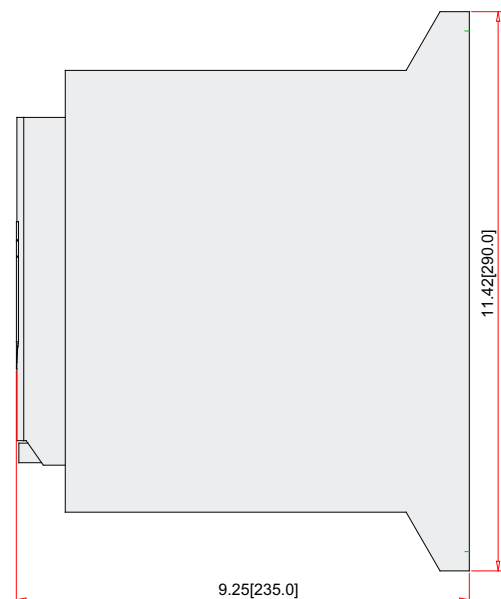

Altistart 48

soft starters for asynchronous motors

Dimensions

Frame Size C

Dimensions

Frame size	ATS48 unit	(W x D x H)	
		in	mm
C	ATS48C14Y... ATS48C17Y	7.9 x 10.4 x 13.4	200 x 265 x 340

Frame size B

Front view

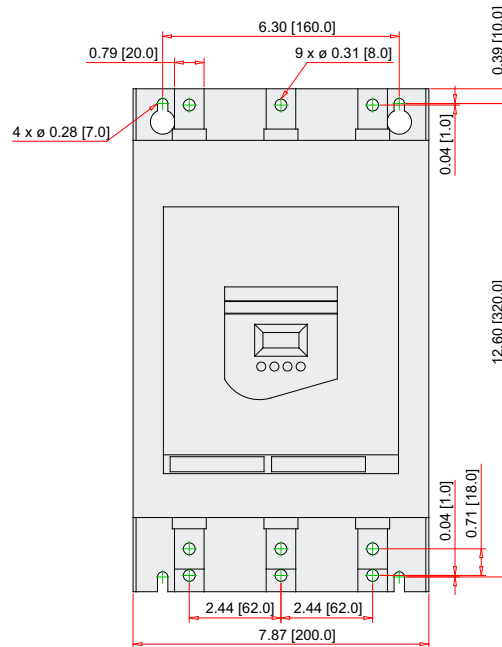

C



ATS48C14Y...
ATS48C17Y

Side view

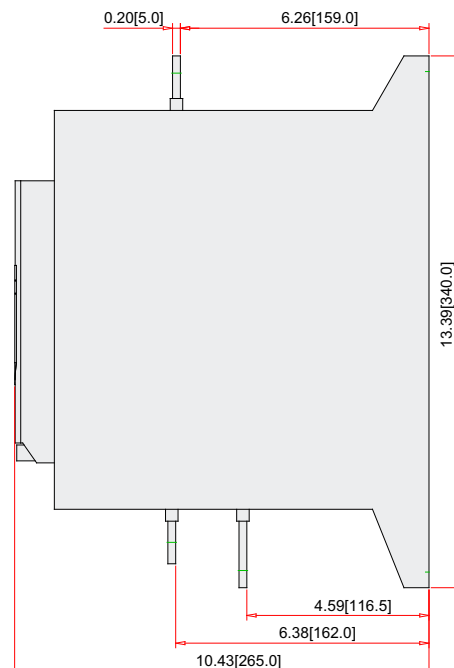

Altistart 48

soft starters for asynchronous motors

Dimensions

Frame Size D

Dimensions

Frame size	ATS22 unit	(W x D x H)	
		in	mm
D	ATS48C21Y... ATS48C32Y	12.6 x 10.4 x 15	320 x 265 x 380

D



ATS48C21Y...
ATS48C32Y

Frame size D

Front view

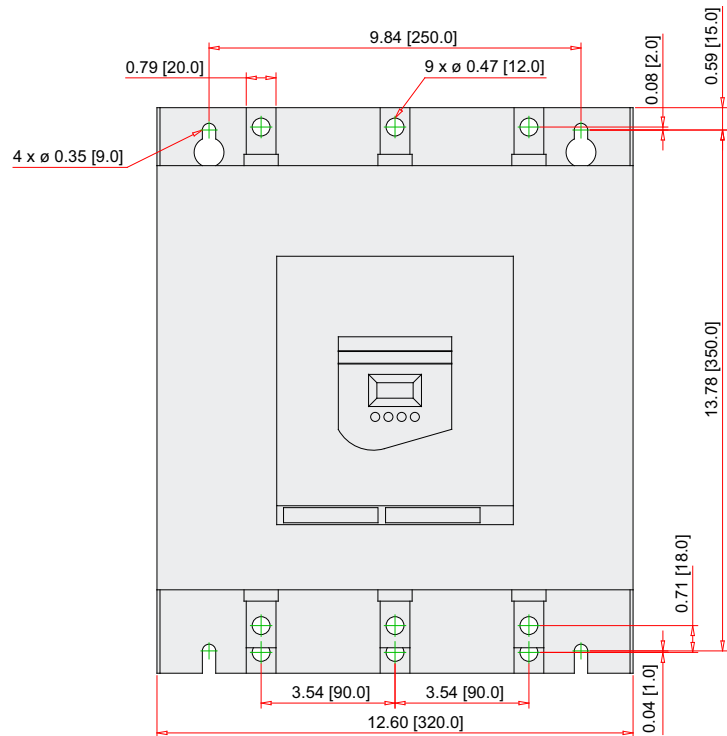

Side view

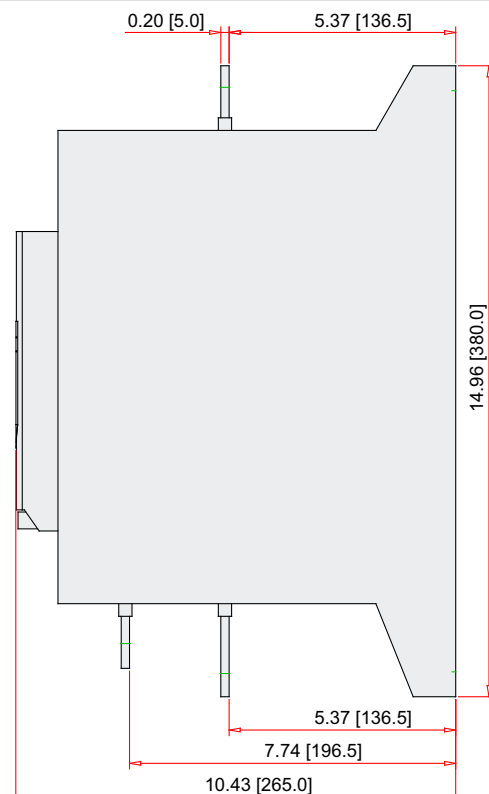

Altistart 48

soft starters for asynchronous motors

Dimensions

Frame size E

Dimensions

Frame size	ATS22 unit	(W x D x H)	
		in	mm
E	ATS48C41Y... ATS48C66Y	15.8 x 11.8 x 26.4	400 x 300 x 670



ATS48C41Y...
ATS48C66Y

Frame size E

Front view

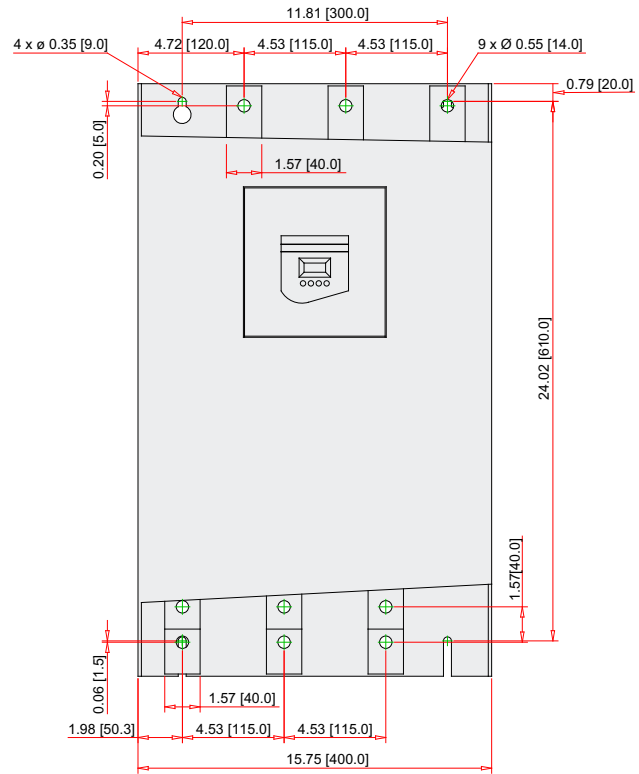

Side view

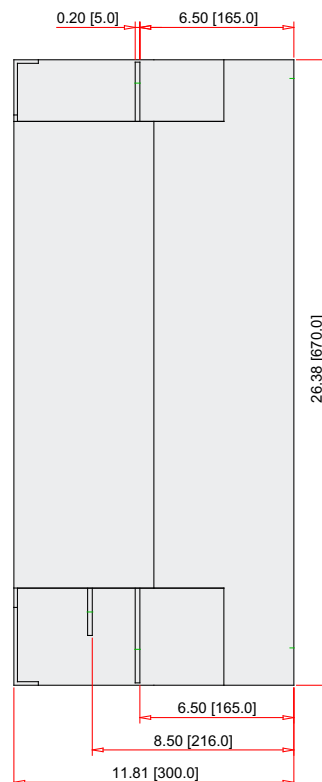

Altistart 48

soft starters for asynchronous motors

Dimensions

Frame size F

Dimensions

Frame size	ATS22 unit	(W x D x H)	
		in	mm
F	ATS48C79Y... ATS48M12Y	30.3 x 12.4 x 35.1	770 x 315 x 890

F



ATS48C79Y...
ATS48M12Y

Frame size F

Front view

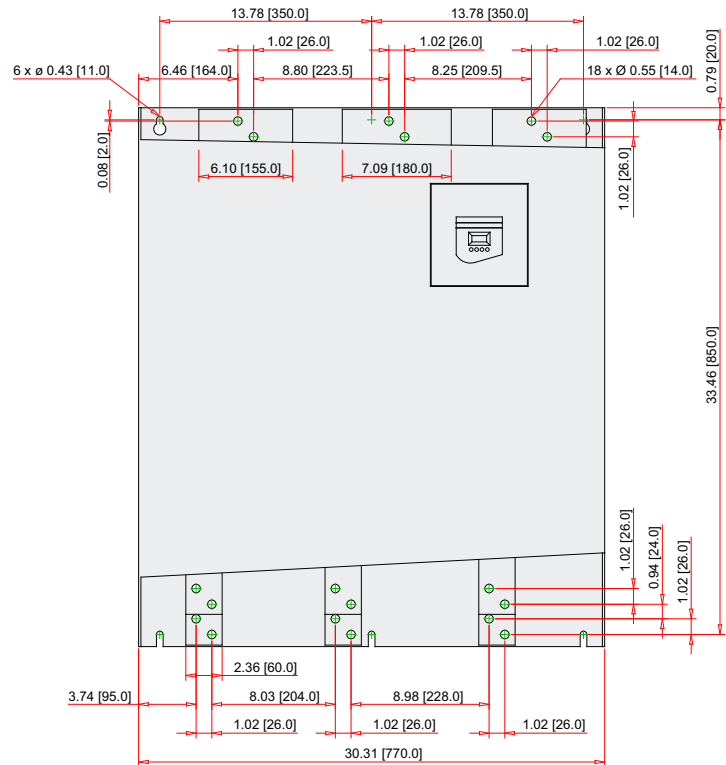

Side view

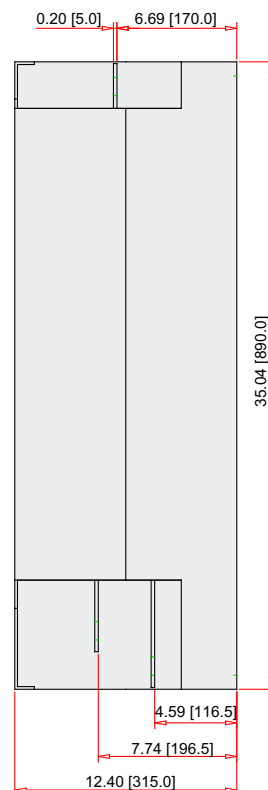

Altistart 48 soft starters for asynchronous motors

Accessories & Options Configuration tools



Configuration tools

SoMove setup software

This software enables the user to configure, set, debug and organize maintenance tasks for the Altistart 48. It can also be used to customize the integrated display terminal menus.

Description	Part number	Weight	
		lbs	kg
SoMove setup software Includes: <ul style="list-style-type: none"> SoMove setup software for PC in English, French, German, Italian, Spanish and Chinese DTMs (Device Type Managers) and technical documentation for variable speed drives, starters and servo motors 	Free Download		
USB/RJ45 cable 1 Used to connect a PC to the device. Cable is 8 ft (2.5 m) long and has a USB connector (PC end) and an RJ45 connector (ATS48 end).	TCSMCNAM3M002P	0.1	0.1
Modbus/Uni-Telway-Bluetooth® adaptor 2 Used to enable any non-Bluetooth® device to communicate via Bluetooth® wireless link ⁽¹⁾ . Includes: <ul style="list-style-type: none"> 1 Bluetooth® adaptor (range 20 m, class 2) with an RJ45 connector For SoMove: 1 x 0.1 m cordset with 2 x RJ45 connectors For TwidoSuite: 1 x 0.1 m cordset with 1 RJ45 connector and 1 mini DIN connector 	TCSWAAC13FB	0.1	0.1
USB-Bluetooth® adaptor for PC 3 Used to enable any non-Bluetooth® PC to communicate via Bluetooth® wireless link ⁽²⁾ . It connects to a USB port on the PC. Range: 33 ft (10 m), class 2	VW3A8115	0.6	0.3
Multi-Loader tool 4 For copying a configuration on a PC or drive and duplicating it on another drive. Includes: <ul style="list-style-type: none"> 1 cordset equipped with 2 RJ45 connectors 1 cordset equipped with USB type A connector and a USB Mini-B type connector 1 x 2 GB SD memory card 1 female/female RJ45 adaptor 4 AA/LR6 1.5 V batteries 	VW3A8121	2.0	0.9



USB/RJ45 cable



Modbus/Uni-Telway-Bluetooth® adaptor



USB-Bluetooth® adaptor for PC



USB-Bluetooth® adaptor for PC

(1) Available only for the following devices:
 - ATV 12, ATV 312, ATV 31, ATV 61 and ATV 71 drives
 - ATS 22 and ATS 48 soft starters
 - TeSys U starter-controllers
 - TeSys T motor management system
 - Lexium 32 servo drives
 (2) Check the manufacturer's specification.

Altistart 48

soft starters for asynchronous motors

Accessories & Options

Accessories



LA9F702

Accessories

Protection shrouds for power terminals

The units ATS48C14Y, ATS48C17Y, ATS48C21Y, ATS48C25Y, and ATS48C32Y have 9 unprotected power terminals. These terminals can be fitted with protection shrouds. The protection shrouds are to be used with eyelet connections.

Description	For soft start - soft stop units	Part number	Weight	
			lbs	kg
Set of 6 power terminal protection shrouds ⁽¹⁾	ATS48C14Y and ATS48C17Y	LA9F702	0.7	0.3
	ATS48C21Y, ATS48C25Y, and ATS48C32Y	LA9F703	0.7	0.3

(1) The soft starters have 9 unprotected power terminals



Remote display terminal

Remote display terminal

The remote keypad display can be mounted on the door of a wall-mounted or floor-standing enclosure. It has the same signalling display and configuration buttons as the keypad display integrated in the Altistart 48. A switch to lock access to the menus is located on the back of the keypad display.

It includes:

- The remote keypad display
- A mounting kit containing a cover, screws and an IP 65 seal on the front panel
- A 9.82 ft (3 m) cable with a 9-pin SUB-D connector (keypad side) and an RJ45 connector (ATS48 side)

Description	Degree of protection	Dimensions		Part number	Weight	
		in	mm		lbs	kg
Remote display terminal kit	IP 65	-	-	VW3G48101	0.4	0.2

Communication modules

Connection via splitter box and RJ45 connectors

Description	Length		Part number	Weight	
	ft	m		lbs	kg
Modbus splitter box with 10 RJ45 connectors and 1 screw terminal block	-	-	LU9GC3	1.1	0.5
DeviceNet/Modbus gateway with 1 DeviceNet screw type and 1 RJ45 Modbus connection	-	-	LUF9	0.5	.23
Cordsets for Modbus serial link with 2 RJ45 connectors	1	0.3	VW3A8306R03	0.06	0.03
	3	1	VW3A8306R10	0.2	0.1
	10	3	VW3A8306R30	0.22	0.1
Modbus T-junction boxes (with integrated cable)	1	0.3	VW3A8306TF03	0.4	0.2
	3	1	VW3A8306TF10	0.4	0.2
Line terminators ^{(2) (3)}	R = 120 Ω C = 1 nF	-	VW3A8306RC	0.02	0.01

(1) Cable depends on the type of controller or PLC

(2) Sold in lots of 2

(3) Depends on the bus architecture



DeviceNet/Modbus gateway

Altistart 48

soft starters for asynchronous motors

Wiring Diagrams

Non-reversing w/ shunt trip fault isolation

Non-reversing with shunt trip fault isolation

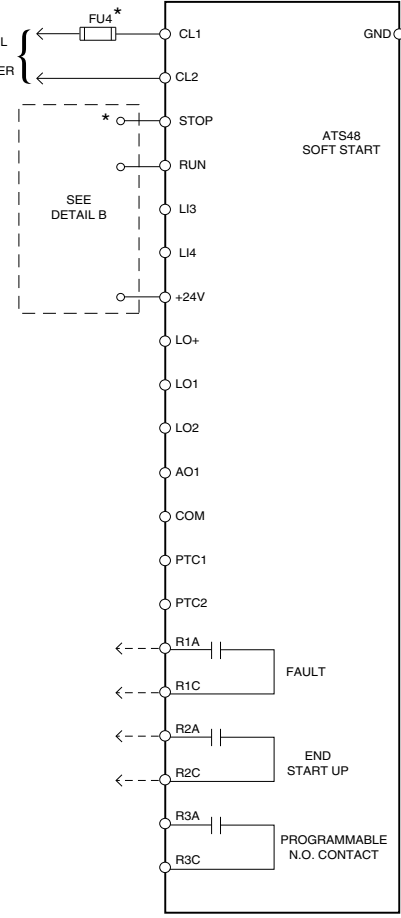
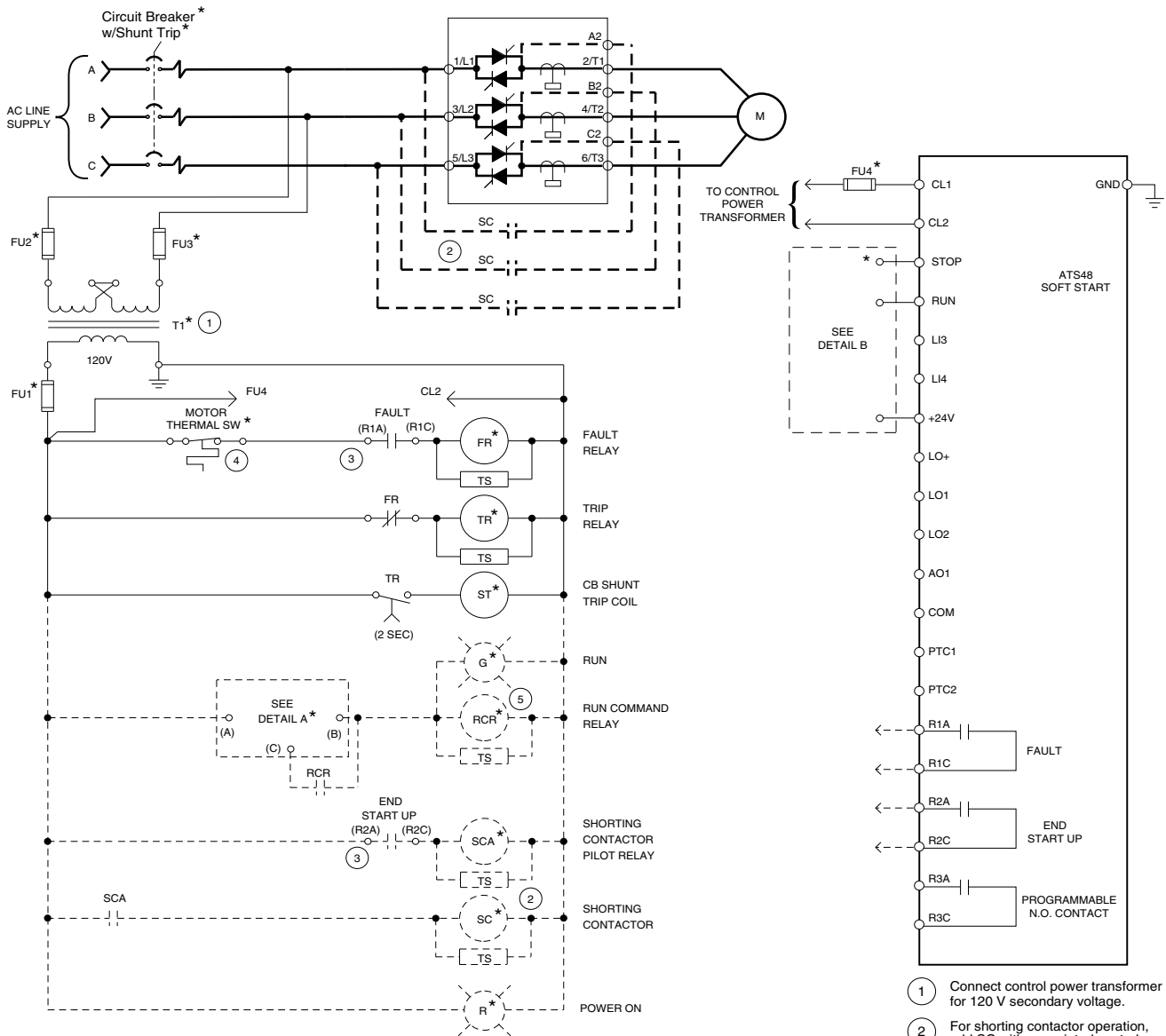

- ① Connect control power transformer for 120 V secondary voltage.
- ② For shorting contactor operation, add SC with associated control circuit.
- ③ Relay contact located on ATS48 controller.
- ④ Located at motor. Jumper if switch not present.
- ⑤ Use RCR relay logic for 120 V control of the ATS48. For 24 Vdc control, omit the RCR relay logic and wire controls directly to the ATS48 (see DETAIL B).

* = User supplied

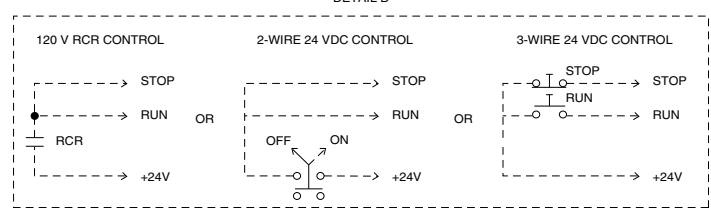
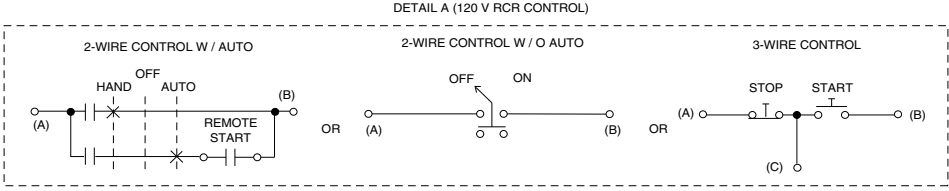

Altistart 48

soft starters for asynchronous motors

Wiring Diagrams

Non-reversing w/ isolation contactor

Non-reversing with isolation contactor

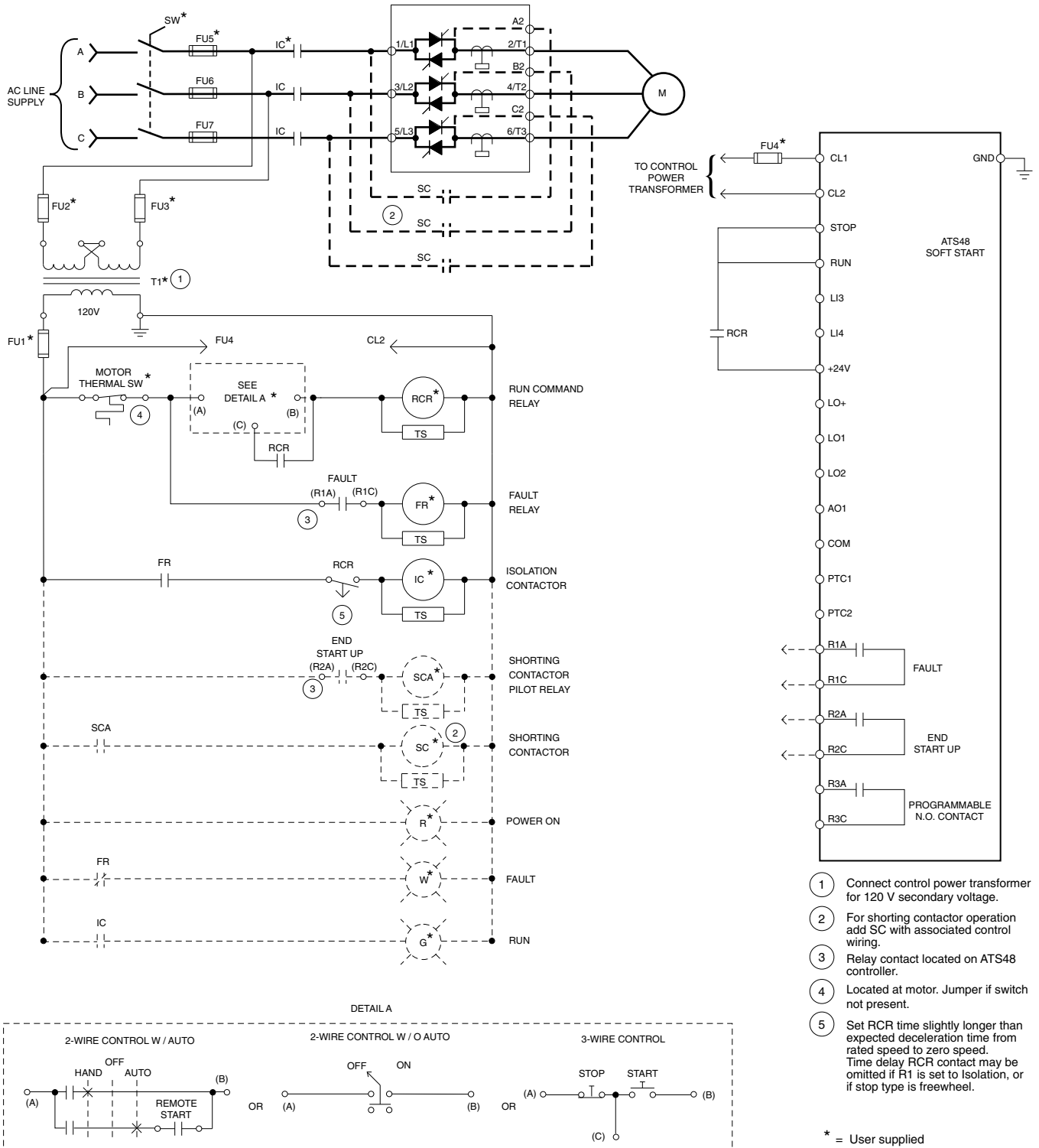

Altistart 48

soft starters for asynchronous motors

Wiring Diagrams

Reversing w/ isolation contactors

Reversing with isolation contactors

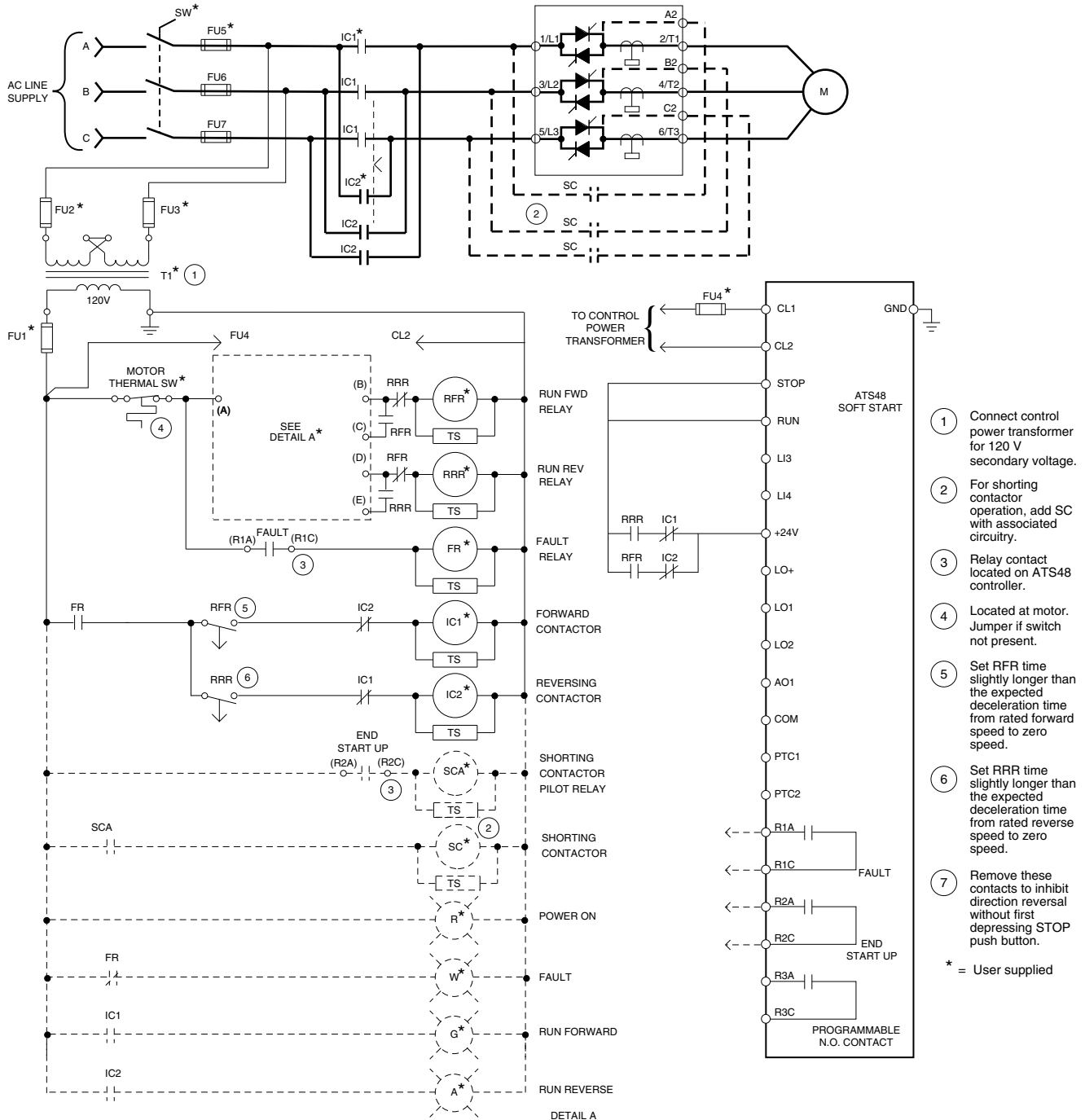

- 1 Connect control power transformer for 120 V secondary voltage.
 - 2 For shorting contactor operation, add SC with associated circuitry.
 - 3 Relay contact located on ATS48 controller.
 - 4 Located at motor. Jumper if switch not present.
 - 5 Set RFR time slightly longer than the expected deceleration time from rated forward speed to zero speed.
 - 6 Set RRR time slightly longer than the expected deceleration time from rated reverse speed to zero speed.
 - 7 Remove these contacts to inhibit direction reversal without first depressing STOP push button.
- * = User supplied

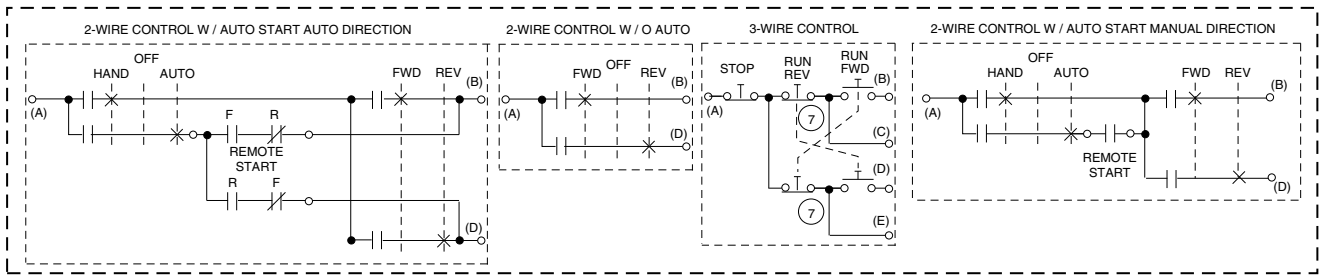

Description of components in wiring diagrams

Item	Name	Description
IC1 IC1A	Isolation Contactor (Fwd)	The isolation contactor logic closes IC1 upon a start command and opens IC1 after the stop is complete. The RCR (or RFR and RRR for reversing) are timed contacts that must have a time delay greater than the deceleration ramp time or the braking time. When a coast stop is selected, the time delay must be set for a time that will allow a complete decay of the motor residual voltage. The isolation contactor will open immediately upon a fault event. The pilot relay (IC1A) is required when the IC1 contactor coil exceeds the ATS48 relay output ratings.
IC2 IC2A	Isolation Contactor (Rev)	Used for reversing applications only, the IC2 must be mechanically interlocked to IC1. A reversing contactor may be used for the combination of IC1 and IC2. In general, the operation of IC2 is identical to IC1. The pilot relay (IC1A) is required when the IC1 contactor coil exceeds the ATS48 relay output ratings.
SC SCA	Shorting Contactor and Pilot Relay	The shorting contactor is used to reduce the heat dissipated by the soft starter when the motor is operating at full speed and voltage. The soft starter provides proper sequencing of this contactor by the "end-start-up" relay. When the start is completed, the shorting contactor will be commanded to close. The soft starter will continue to monitor the motor thermal state and provide motor overload protection. Upon a stop command, the SC contactor will open, transferring the motor current to the ATS48 soft starter to allow for controlled deceleration if desired. The pilot relay (SCA) is required when the SC contactor coil exceeds the ATS48 relay output ratings.
TS	Transient Suppressors	Transient suppression of all relay and contactor coils (except ST) is recommended to minimize the possibility of electrical interference with the soft starter electronics and to increase relay contact life.
RCR	Run Command Relay	Used in shunt trip fault isolation installations only if 120 V control of the ATS48 soft starter is required. Used in non-reversing installations with a isolation contactor for proper sequencing of contactor logic. When energized, RCR initiates the start sequence. When de-energized, stopping is initiated. Operator controls can be either on/off selector switch, HOA selector switch or start/stop push buttons. RCR remains energized during a fault event. Once the fault condition has been cleared, RCR must be de-energized by a "stop" command then re-energized to restart the soft starter.
RFR	Run Forward Relay	Used for reversing applications only, this coil duplicates the functionality of RCR for the forward direction and is interlocked with the RFR relay.
RRR	Run Reverse Relay	Used for reversing applications only, this coil duplicates the functionality of RCR for the reverse direction and is interlocked with the RRR relay.
ST	Shunt Trip Coil	This coil is attached to the shunt trip coil on the disconnect and will energize 2 seconds after a soft start detected fault by the TR timer contact. The time delay is to prevent nuisance tripping of the circuit breaker during soft starter power-up or during line undervoltage conditions.
TR	Trip Relay	Used in shunt trip circuit breaker logic only; coil energized upon a soft starter detected fault.
FR	Fault Relay	The fault relay is energized during normal operation and de-energizes if the soft starter detected fault contacts open or if the motor thermal switch (if supplied) opens. FR also provides additional contacts for the soft starter fault output.

Altistart 48

soft starters for asynchronous motors

Suggested Components

Standard duty

Suggested components for standard duty applications

Induction Motor				ATS48 Soft Starter		FU4	
Rated HP ⁽¹⁾				Altistart 48 Soft Starter	Device Rated Current	ATS Control	Class CC 600 V Time Delay
208 V	230 V	460 V	575 V		@ 40 °C (104 °F) ⁽²⁾	Power Burden (W)	@ 115 V
3	5	10	15	ATS48D17Y	17	25	0.5 A
5	7.5	15	20	ATS48D22Y	22	25	0.5 A
7.5	10	20	25	ATS48D32Y	32	30	0.6 A
10	—	25	30	ATS48D38Y	38	30	0.6 A
—	15	30	40	ATS48D47Y	47	30	0.6 A
15	20	40	50	ATS48D62Y	62	30	0.6 A
20	25	50	60	ATS48D75Y	75	30	0.6 A
25	30	60	75	ATS48D88Y	88	30	0.6 A
30	40	75	100	ATS48C11Y	110	30	0.6 A
40	50	100	125	ATS48C14Y	145	30	0.6 A
50	60	125	150	ATS48C17Y	170	30	0.6 A
60	75	150	200	ATS48C21Y	210	50	1 A
75	100	200	250	ATS48C25Y	250	50	1 A
100	125	250	300	ATS48C32Y	320	50	1 A
125	150	300	350	ATS48C41Y	410	80	1.5 A
150	—	350	400	ATS48C48Y	480	80	1.5 A
—	200	400	500	ATS48C59Y	590	80	1.5 A
200	250	500	600	ATS48C66Y	660	80	1.5 A
250	300	600	800	ATS48C79Y	790	80	1.5 A
350	350	800	1000	ATS48M10Y	1000	80	1.5 A
400	450	1000	1200	ATS48M12Y	1200	80	1.5 A

(1) Motor full load currents through 500 hp@460/575 V, 250 hp@230 V, and 200 hp@208 V are taken from the National Electric Code (NFPA 70-2002, Table 430.150). Above these ratings, motor full load currents are calculated based upon 1.2 A/hp for 460 V and 2.4 A/hp for 230 V. Motors listed are for standard duty applications. For severe duty applications, select the next larger soft starter size.

(2) The ambient temperature indicated in the table represents the temperature of the air surrounding the ATS48 soft starter. Any additional temperature factors associated with the enclosure system or actual installation ambient temperature must be considered when determining the actual rated current (ICL) of the soft starter. For operating ambient above 40 °C (104 °F) without a shorting/bypass contactor and 50 °C (122 °F) with a shorting/bypass contactor but not exceeding 60 °C (140 °F), the rated current (ICL) of the soft starter must be de-rated by 2% per °C.

Altistart 48

soft starters for asynchronous motors

Suggested Components

Standard duty

Additional Suggested Components for Standard Duty Applications ⁽¹⁰⁾

ATS48 Soft Starter	Contactors ^{(1), (2), (3)}				Disconnect ⁽⁴⁾			
	IC1	IC2		SC	Fusible Disconnect			Circuit Breaker
ATS48 Model	Isolation Contactor	Reversing Contactor ⁽⁵⁾	Mechanical Interlock	Shorting Contactor (AC1)	Power Fuses Class/Rating	Fuse Block ⁽⁶⁾	Molded Case Switch ⁽⁷⁾	Thermal Magnetic ⁽⁷⁾
ATS48D17Y	LC1D09	LC1D09	(8)	LC1D09	J/25	60308J	HGL36000S15	HDL36030
ATS48D22Y	LC1D18	LC1D18	(8)	LC1D18	J/30	60308J	HGL36000S15	HDL36040
ATS48D32Y	LC1D25	LC1D25	(8)	LC1D25	J/40	60608J	HGL36000S15	HDL36050
ATS48D38Y	LC1D32	LC1D32	(8)	LC1D32	J/50	60608J	HGL36000S15	HDL36060
ATS48D47Y	LC1D40	LC1D40	(8)	LC1D40	J/60	60608J	HGL36000S15	HDL36080
ATS48D62Y	LC1D50	LC1D50	(8)	LC1D50	J/80	61038J	HGL36000S15	HDL36090
ATS48D75Y	LC1D80	LC1D80	(8)	LC1D80	J/100	61038J	HGL36000S15	HDL36100
ATS48D88Y	LC1D80	LC1D80	(8)	LC1D80	J/120	62003J	JGL36000S25	HDL36110
ATS48C11Y	LC1D115	LC1D115	(8)	LC1D115	J/150	62003J	JGL36000S25	HDL36150
ATS48C14Y	LC1D115	LC1D115	(8)	LC1D115	J/200	62003J	JGL36000S25	JGL36200
ATS48C17Y	LC1F150	LC1F150	LA9FF970	LC1F150	J/225	64033J	LHL36000M	LAL36225
ATS48C21Y	LC1F185	LC1F185	LA9FG970	LC1F185	J/300	64033J	LHL36000M	LAL36250
ATS48C25Y	LC1F225	LC1F225	LA9FJ970	LC1F225	J/350	64033J	LHL36000M	LAL36350
ATS48C32Y	LC1F330	LC1F330	LA9FJ970	LC1F330	J/400	64033J	LHL36000M	LAL36400
ATS48C41Y	LC1F400	LC1F400	LA9FJ970	LC1F400	J/500	6633J	PJL36000S60	MGL36500
ATS48C48Y	LC1F500	LC1F500	LA9FJ970	LC1F500	J/600	6633J	PJL36000S60	MGL36600
ATS48C59Y	LC1F500	LC1F500	LA9FJ970	LC1F500	L/700	(6)	PJL36000S80	MGL36800
ATS48C66Y	LC1F630	LC1F630	LA9FJ970	LC1F630	L/900	(6)	PJL36000S80	MGL36900
ATS48C79Y	LC1F630	LC1F630	LA9FL970	LC1F630	L/110	(6)	PJL36000S10	(9)
ATS48M10Y	LC1F780	LC1F780	LA9FL970	LC1F780	L/1350	(6)	PJL36000S10	(9)
ATS48M12Y	LC1F780	LC1F780	LA9FX970	LC1F780	L/1600	(6)	PJL36000S12	(9)

(1) All coils are selected for 120 V, 60 Hz operation. Refer to the Digest for additional coil voltages or auxiliary contact configurations. One block may be added to each contactor.

(2) Power terminals are not included with LC1-F contactors. For additional ordering information visit www.schneider-electric.com.

(3) The use of transient suppressors across all contactor coils is recommended. Refer to the latest editions of Schneider Electric's full line product catalogs for selection of transient suppressors.

(4) According to the National Electric Code, branch circuit overcurrent protection must be provided for each soft starter.

(5) Reversing contactors for C11 through M12 soft starters must be assembled from components. Parts quantities for a basic contactor assembly, minus the power connection links and terminals, are indicated before each part number. Refer to the latest editions of Schneider Electric's full line product catalogs for power connector link and terminal kits. Reversing contactor interlock units used for the C79 through M12 soft starters are designed for vertical interlocking of the individual contactors. Horizontally interlocked contactors are used for D17 through C59 soft starters.

(6) Fuse holder part number references are for Class J fuses only based on Ferraz Shawmut spring reinforced with box type connectors acceptable for Al/Cu wiring. Class L fuses require bolt-on connections to user-supplied power bus work.

(7) The molded case switches and circuit breakers selected require the addition of operator mechanisms to allow operation from the exterior of an enclosure. Refer to the latest editions of Schneider Electric's full line product catalogs for operator mechanism information. When using a shunt trip relay for SCR fault isolation, order a disconnect switch with suffix -1021 for addition of shunt trip coil.

(8) The D Line contactor is available as a reversing configuration. For these applications, change the IC1 part number prefix from LC1- to LC2- to order the IC1 and IC2 combination complete with mechanical interlocks.

(9) Devices rated above 660 A have not been coordinated with circuit breakers. You must use a Class L fuse for overcurrent protection with ATS48 soft starter models C79, M10, and M12.

(10) For UL508A combinations, go to www.schneider-electric.com.

Conventional starting curves

The following graphs illustrate the starting curves of commonly used starting methods for starting a motor.

Direct starting

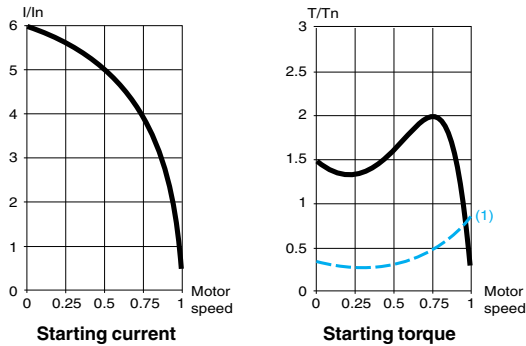

- Starting current: 4 to 8 times the nominal current
- Starting torque: 0.5 to 1.5 times the nominal torque
- Characteristics:
 - Motor with 3 terminals, low and medium power
 - On-load starting
 - High current peak and voltage drop
 - Simple device
 - Sudden starting for the mechanism
- No parameter adjustment

(1) Load torque

Wye delta starting

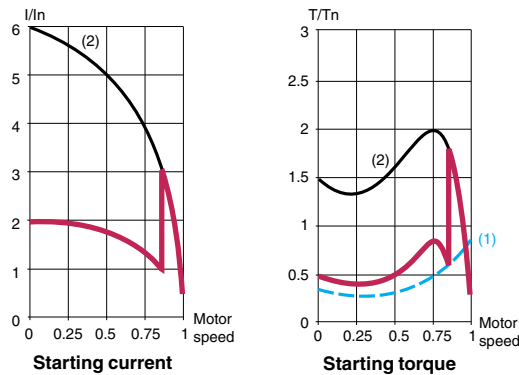

- Starting current: 1.8 to 2.6 times the nominal current
- Starting torque: 0.5 times the nominal torque
- Characteristics:
 - Motor with 6 terminals
 - No-load or low resistive torque starting
 - High current peaks and torque when changing to "Wye Delta" mode
 - A device requiring maintenance
 - Subject to mechanical stress when starting
- No parameter adjustment

(1) Load torque
(2) Direct Starting

Primary resistor starting

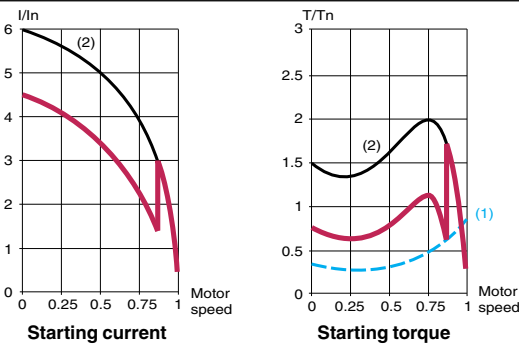

- Starting current: 4.5 times the nominal current
- Starting torque: 0.5 to 0.75 times the nominal torque
- Characteristics:
 - Motor with 3 terminals, high power
 - Starting with increasing resistive torque
 - High current peak
 - A large, bulky device requiring maintenance
 - Subject to mechanical stress when starting
- No parameter adjustment

(1) Load torque
(2) Direct Starting

Autotransformer starting

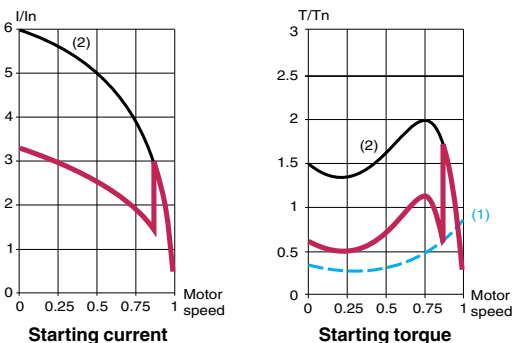

- Starting current: 1.7 to 4 times the nominal current
- Starting torque: 0.4 to 0.85 times the nominal torque
- Characteristics:
 - Motor with 3 terminals, high power
 - Large voltage drop and current peak when connected at full voltage
 - A complex, bulky device requiring maintenance
 - Subject to mechanical stress when starting
- No parameter adjustment

(1) Load torque
(2) Direct Starting

Altistart 48

soft starters for asynchronous motors

Conventional Starting Curves

Conventional starting curves (continued)

The following graphs illustrate the starting curves of commonly used starting methods for starting a motor.

Conventional Electronic Starting With Voltage Ramp And Current Limit

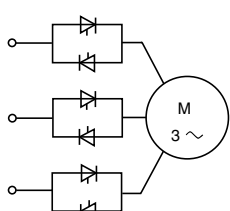

Schematic diagram

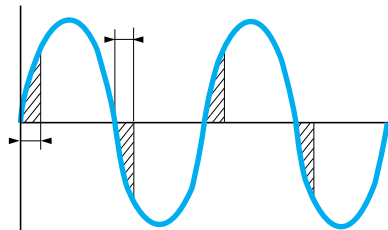

Firing angle

- A soft starter with 6 thyristors connected head-to-tail in each line phase is used to power the three-phase asynchronous motor by gradually increasing the voltage on start-up.
 - Depending on the firing time and angle of the thyristors, it can be used to supply a voltage which will gradually increase at a fixed frequency.
 - The gradual increase in the output voltage can either be controlled by the acceleration ramp, or by the value of the limiting current, or linked to both parameters.

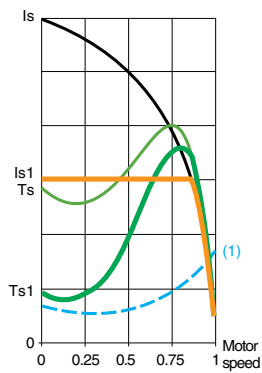

Figure 1

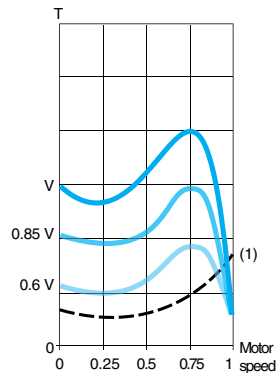

Figure 2

- Figure 1 shows the behavior of the torque in relation to the starting current. Limiting the starting current I_{s1} to a preset value I_{s1} will reduce the starting torque T_{s1} to a value which is almost equal to the ratio of the square of currents I_s and I_{s1} .

Example

On a motor with the following characteristics: $T_s = 2 T_n$ for $I_s = 6 I_n$, current limiting at $I_{s1} = 3 I_n$ or $0.5 I_s$ results in a starting torque: $T_{s1} = T_s \times (0.5)^2 = 2 T_n \times 0.25 = 0.5 T_n$. (T_n is motor rated torque; I_n is motor rated current.)

- Figure 2 shows the torque/speed characteristic of a squirrel cage motor in relation to the supply voltage. The torque varies like the square of the voltage at a fixed frequency. The gradual increase in the voltage prevents the instantaneous current peak on power-up.

(1) Load torque

Advantages of starting with the Altistart 48



Conventional electronic starting

To rectify problems caused by:

- Mechanical stress when starting
- Hydraulic transients during acceleration and deceleration in pump applications

Conventional electronic starting requires the use of several current limits or the switching of several voltage ramps. The settings become complicated and must be modified every time the load changes.

Starting with the Altistart 48

The ATS48 soft starter's torque control enables:

- Starting without mechanical stress
- Smooth control of hydraulic transients with a single acceleration ramp
- Simple and effective settings, whatever the load.

Altistart 48 soft starters for asynchronous motors

Enclosed Altistart 48 Introduction



Introduction

The **Altistart 48 Enclosed Soft Starter Controller** packages the advanced functionality of the Altistart 48 soft start - soft stop unit and a disconnect means in a Type 1, Type 12, or Type 3R stand-alone enclosure. It is a pre-engineered, integrated solution for soft starting and soft stopping of standard three-phase asynchronous induction motors from 3 HP to 600 HP at 600 V. This industry leading package greatly improves your machine's performance and reliability while cutting installation costs.

The Altistart 48 soft starter enclosed in this offer features many strong motor starting and stopping functions. The patented Torque Control System (TCS) provides linear starting and stopping control, independent of motor load. This feature of the Altistart 48 controls the applied motor torque, making it ideal for a wider variety of applications than a traditional voltage ramp soft start with current limit. More information on the functionalities of the Altistart 48 device enclosed in this offer can be found beginning on page 4 of this catalog.

The Enclosed Altistart 48 is rated for normal and heavy duty applications. It is available with a fusible disconnect (Class 8638) or with a circuit breaker (Class 8639). The device software is factory configured to match the power and control options purchased with the enclosed controller for simple set-up.

Applications

The Enclosed Altistart 48 offers soft starting and deceleration functions, machine and motor protection functions, and functions for communicating with control systems. These functions are designed for use in the following normal or heavy duty applications in the buildings, food and beverage, and chemical industries:



Application type	Functions performed by the Altistart 48
Pumps Normal duty	<ul style="list-style-type: none"> ■ Better control of hydraulic transients: <ul style="list-style-type: none"> - Gradual pressurization of fluid in lines - Reduction of pressure surges and valve surges (in presence of line supply) - Elimination of damage to filters or spouts (irrigation) and premature wear of lines, etc. - Less stress on pipes with the reduction of pressure-over pressure phenomena ■ Independent adjustment of the load conditions ■ Protection against underload (running dry), loss or inversion of phases and in the event of a locked rotor ■ Automatic switching of the motor to freewheel mode on stopping, when the flow rate of the pump drops to a low level, to prevent overheating.
Conveyors Normal duty	<ul style="list-style-type: none"> ■ Gradual starting, reducing shocks and slipping of belts ■ Overload control to detect faults, hard spots or jamming, or underload control to detect breaks
Fans & high inertia machines Normal or Heavy duty (>30 s)	<ul style="list-style-type: none"> ■ Smooth starting, preventing stress on the drive chain and slipping of belts ■ "Smoke extraction" function ■ Limitation of current and voltage drops on starting ■ Catching on the fly of a fan rotating in reverse ■ Detection of overload caused by clogging or underload (broken fan motor transmission) ■ Braking torque on stopping
Compressors Normal or Heavy duty (>30 s)	<ul style="list-style-type: none"> ■ Elimination of slipping of belts ■ Reduction of current peaks ■ Protection even for special motors ■ Detection of inversion of direction of rotation of phases ■ Contact for automatic emptying on stopping

Altistart 48

soft starters for asynchronous motors

Enclosed Altistart 48

Introduction



Product

The Enclosed Altistart 48 is offered in 3 different enclosure types; UL Type 1, UL Type 12/12K, and 3R. The horsepower ratings for the Enclosed Altistart 48 are:

- 3–200 HP @ 208 Vac, 60 Hz
- 5–250 HP @ 230 Vac, 60 Hz
- 10–500 HP @ 460 Vac, 60 Hz
- 15–600 HP @ 575 Vac, 60 Hz

Each Enclosed Altistart 48 contains:

- Current limiting provisions to achieve short circuit ratings for the unit
- Customer terminal blocks for 120 V control connections
- A disconnect (circuit breaker or fused switch) with an external handle
- A door mounted keypad display for diagnostics and set up
- AC1 duty shorting contactors which bypasses the soft starter when full voltage level is reached upon starting
- Various control and power contactor options may be included in the Enclosed Altistart 48 controller. Factory order specific drawings will list all included options.
- Load terminals (T1/T2/T3) for motor connections to the Altistart 48 soft starter.
- Solid state overload protection built in to the Altistart 48 soft starter.

The Enclosed Altistart 48 is EGSA Class 3 Generator compliant for use on emergency/standby generators.

For information about how to apply and adjust the Enclosed Altistart 48 soft starter for a particular installation, refer to the Enclosed Altistart 48 Instruction Bulletin.

Benefits of the Enclosed Altistart 48

- **Reduced torque during starting**
 - Prevents damage to material in process
 - Increases the life of your machine and reduces downtime
- **Reduced current peaks on the supply during starting**
 - Lowers plant capacity requirements
 - Reduces voltage sag on installations with limited capacity
 - Eliminates detrimental effects on other equipment driven from a weak supply
- **Smooth acceleration and deceleration independent of changes in motor load**
 - Ideally suited for most fans, centrifugal pumps, or other variable-torque loads
 - Can eliminate water hammer and check valve slamming even on difficult pumping applications
- **Advanced protection for the motor and the installation**
 - Selectable overload protection class, overload pre-alarm, phase loss and reversal protection, stall protection during starting, protection from material jams while running, and under-load detection
- **Service entrance rating**
 - Provides a factory-installed ground neutral assembly with ground wire and label for use as service entrance rated equipment
- **SoMove setup software**
 - Use the user friendly SoMove setup software to easily configure, set-up, and maintain the Altistart 48



Altistart 48

soft starters for asynchronous motors

Enclosed Altistart 48

Introduction

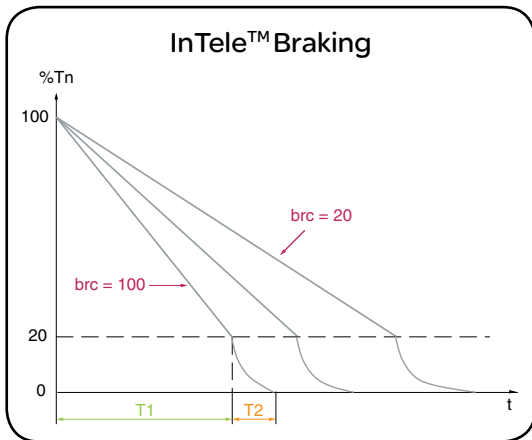
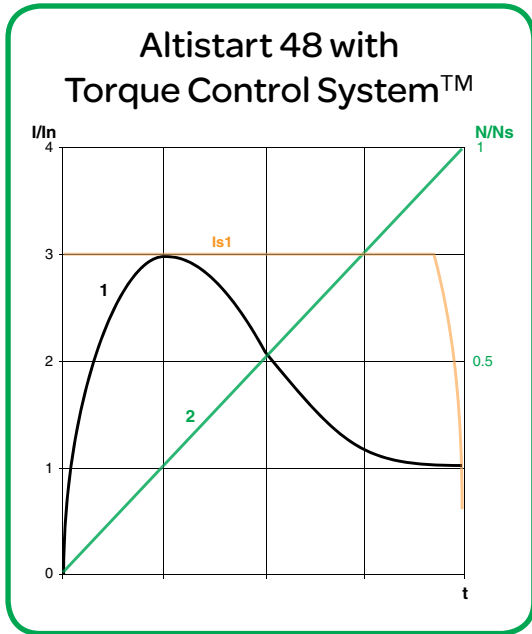

InTele braking stops for different braking torque levels (*brc*)

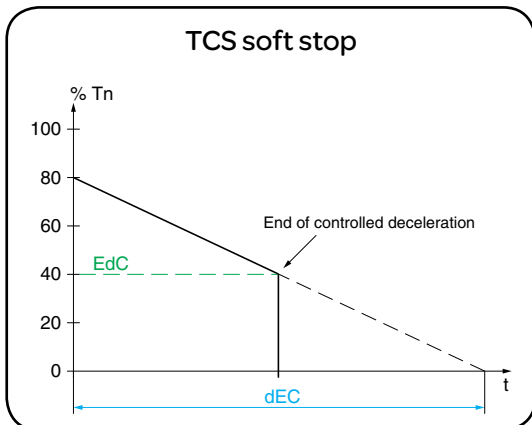

Decelerated stop by torque control during time (*dEC*) with threshold (*EdC*) for changing to freewheel stop mode
EdC = 40% of nominal motor torque

Product (continued)

Product features

Starting and Stopping

- Four types of starting:
 - Torque control system (TCS) soft starting - adjustable from 1 to 60 seconds
 - TCS with boost - adjustable from 50 to 100% of main voltage
 - Current limit - adjustable from 150 to 500% of controller rating
 - Voltage ramping
- Three types of stopping:
 - Freewheel or coast to stop
 - TCS soft stop - adjustable from 1 to 60 seconds
 - InTele™ braking - adjustable from 50 to 100%

Protection

- Motor thermal overload, motor phase loss and soft starter thermal protection
- Line supply failure, over-current fault, and locked rotor fault protection
- Line frequency outside limits of $\pm 5\%$ or $\pm 20\%$
- EGSA compliance with Class 3 application (droop operation) generators
- Seismic qualified (floor mount configurations) to the International Code Council Evaluation Service (ICC ES)
- Protection options:
 - Phase reversal
 - Stall and jam
 - Thermal overload pre-alarm
 - Current threshold alarm
 - Under-load fault detection

Monitoring and indication

- Door-mounted keypad
 - Displays setup parameters and fault codes for the previous five fault events
 - Real-time indication via the digital keypad
 - Motor current
 - Load torque
 - Motor thermal starter
 - Power factor
 - Detected fault status
- Three logic outputs
 - Motor thermal overload or indication of motor current present
 - Current threshold alarm
 - Motor under-load alarm

Environmental specifications

Degree of protection	<ul style="list-style-type: none"> ■ Type 1: Indoor use primarily to provide a degree of protection against limited amounts of falling dirt. ■ Type 12: Indoor use primarily to provide a degree of protection against circulating dust, falling dirt, and dripping noncorrosive liquids. ■ Type 3R: Outdoor use primarily to provide a degree of protection against rain, sleet, and damage from ice formation. ■ Enclosures are painted ANSI #49
Conformity to standards	UL listed per UL508; CSA Certified per CSA 22.2 No. 14. Immunity to radioelectrical interference: conforms to IEC 61000-4-3 Level 3.
Operational test vibration	Conforms to IEC 60068-2-6, 1.5 mm peak from 2 to 13 Hz, 1 gn from 13 to 200 Hz
Seismic qualification	Available as an optional feature (MOD Y10). Provides a qualification label and hardware qualified to seismic rating per ICC ES AC156 for compliance to the seismic provisions of the International Building Code and ASCE 7.
Transit test to shock	Conforms to the National Safe Transit Association and International Safe Transit Association test for packages weighing 100 lbs and over.
Ambient air temperature	<ul style="list-style-type: none"> ■ Operation: Ambient conditions in installed area from <ul style="list-style-type: none"> □ Type 1 and 12: 32 to 104 °F (0 to 40 °C) □ Type 3R: 32 to 122 °F (0 to 50 °C) ■ Storage: -13 to 158 °F (-25 to +70 °C)
Maximum ambient pollution	Conforms to IEC 60664-1, Pollution Degree 3
Maximum relative humidity	95% without condensation or dripping water conforming to IEC 60068-2-78
Maximum operating altitude	1000 m (3280 ft.), derate by 2.2% for each additional 100 m (328 ft) up to 3000 m (9842 ft) maximum.

Electrical specifications

3-phase Supply Voltage	208 Vac ± 10% 230 Vac ± 15% 460 Vac ± 15% 575 Vac ± 10%
Control Voltage	115 Vac [Control Power Transformer (CPT) included as standard]
Frequency	50/60 Hz +/- 5%
Rated Current	17 A to 1200 A
Motor Power	3 to 600 hp
Motor Voltage	208, 220, 230, 240, 460, 480, 575, 600 V
Starting Duty (Standard Duty)	Starting at 400% of In for 23 s, or 300% of In for 46 s, from a cold state Starting at 400% of In for 12 s, or 300% of In for 23 s, with a load factor of 50% and 10 starts per hour or an equivalent thermal cycling

(1) In is the controller full load current listed on the nameplate.

Operation specifications

Methods of Starting	
Torque Ramp	Adjustable from 1 to 60 s by keypad
Current Limitation	Adjustable from 150% to 500% of controller rated current (In) by keypad
Booster Start-up Pulse	Full voltage starting for 5 cycles of 50 to 100% mains voltage, selectable by keypad.
Methods of Stopping	
Freewheel	Coast to stop on stop command
Torque Deceleration Ramp	Adjustable from 1 to 60 s by keypad
InTele Braking	Selectable by keypad.
Status and Diagnostics:	Digital display of motor and controller status, including: <ul style="list-style-type: none"> ■ Ready/Run/Detected Fault ■ Motor Current ■ Motor Torque ■ Motor Thermal State ■ Power Factor

Protection specifications

Motor	
Thermal Overload	With Full Voltage Bypass: A bimetallic or solid state Class 20 (MOD A10) overload relay is integral to the ATS48 soft starters. Without Full Voltage Bypass: A solid state thermal overload is integral to the ATS48 soft starter. Overload class is selectable as 10, 20, or 30 via keypad. Range is 50% to 100% of ATS48 soft starter rated current.
Shunt-Trip Disconnect	Removes all power from the controller cabinet when the Altistart 48 detects a fault condition.
Isolation Contactor	Removes supply power from the Silicon Control Rectifier (SCR) power circuit and motor when the motor is not running or when the Altistart 48 detects a fault condition.
Controller	
Overcurrent Protection	An overcurrent protection device (OCPD) provides Type 1 coordination to the short-circuit current withstand ratings.
Shorting Contactor	A standard shorting contactor reduces temperature rise within the enclosure by eliminating the watts loss of the SCRs. Control of the contactor allows all forms of stopping.
Thermal Switch	Controllers rated for 17–62 A have one thermal switch to help protect against overheating. Controllers rated 72 A and greater have 2 thermal switches; one controls the fan, the other helps protect against overheating.

Short circuit current ratings

Enclosure Size	Horsepower Rating				8638 Fusible Disconnect	8639 Circuit Breaker
	208 V	230 V	460 V	575 V		
A-C	3-50	5-60	10-125	15-150	100K	65K
D	60-100	75-125	150-250	200-300	100K	30K
E	125-200	150-250	300-500	350-600	65K	65 or 100K ¹

(1) 100K is only available when option 610 is selected. See page 51.

Altistart 48

soft starters for asynchronous motors

Enclosed Altistart 48

Selection criteria

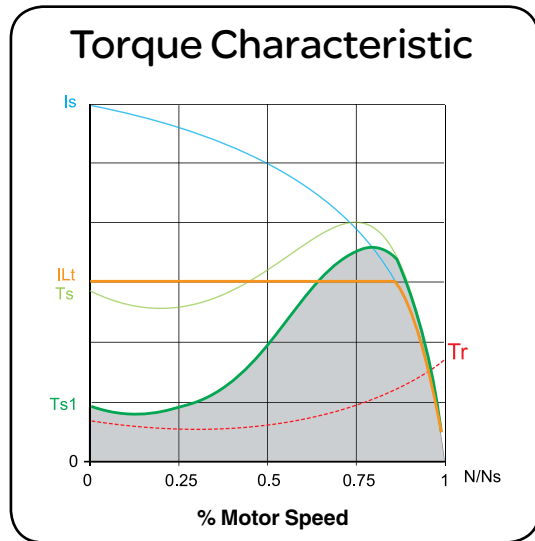

Asynchronous motor

Ts: Across the line starting torque

Is: Across the line starting current

Altistart 22

Ts1: Total torque range available with an Altistart 48, which is dependent on the current limit (**Is1**) setting.

Load

Tr: Resistive torque must always be less than the Ts1 torque, or the motor will not start.

Selection Criteria

In addition to the chosen application, the choice of starter will depend on the following main criteria:

- **AC mains voltage supply:**
 - Three-phase AC voltage: 208, 240, 480, or 600 V
- **Power and nominal current (In) indicated on the motor name plate**
- **Duty cycle**
- **Starting current capacity**

Whether an application is a standard duty or severe duty application determines the limiting values of the current and the duty cycle ratings.

Duty cycle

S1 motor duty: Duty cycle of starting followed by operation at constant load enabling the thermal stability to be reached.

S4 motor duty: Duty cycle of starting, operation at constant load, and an idle period. This cycle is characterized by a load factor.

These motor duties are described in more detail in IEC 60034-1.

Starting current capacity - Standard duty

In standard duty applications, the ATS48 soft starter is designed to provide:

- **S1 motor duty:**
 - Starting at 4 In for 23 seconds with a cold motor
 - Starting at 3 In for 46 seconds with a cold motor
- **S4 motor duty** (with a load factor of 50% and 10 starts per hour):
 - Starting at 4 In for 12 seconds
 - Starting at 3 In for 23 seconds
 - or an equivalent thermal cycle

The motor thermal protection conforms to Class 30, Class 25, Class 20 (severe duty application), Class 15, Class 10 (standard duty application), Class 10 A, and sub-class 2 motor thermal overload protection (see page 10).

Starting current capacity - Severe duty

In severe duty applications, the ATS48 soft starter is designed to provide:

- **S1 motor duty:**
 - Starting at 4 In for 48 seconds with a cold motor
 - Starting at 3 In for 90 seconds with a cold motor
- **S4 motor duty** (with a load factor of 50% and with 5 starts per hour):
 - Starting at 4 In for 23 seconds
 - or an equivalent thermal cycle

The motor thermal protection conforms to Class 30, Class 25, Class 20 (severe duty application), Class 15, Class 10 (standard duty application), Class 10 A, and sub-class 2 motor thermal overload protection (see page 10).

Selecting the Soft Starter

First, identify the application type and corresponding starting current on page 46. Once the application type has been identified, begin building your unique part number using the information presented on pages 48-51, according to your supply voltage and the motor power requirements.

Altistart 48

soft starters for asynchronous motors

Enclosed Altistart 48

Selection criteria

Application types

Depending on the type of machine, the applications are categorized as standard or severe duty based on the starting characteristics. Examples are given in the table below.

Standard Applications

Type of machine	Functions performed by the ATS48	Starting current (%In)	Starting time (s)
Centrifugal pump	<ul style="list-style-type: none"> Deceleration (reduction in pressure surges) Protection against underloads or inversion of the phase rotation direction 	300	5 to 15
Piston pump	<ul style="list-style-type: none"> Control of running dry and direction of rotation of the pump 	350	5 to 10
Cold compressor	<ul style="list-style-type: none"> Protection, even for special motors 	300	5 to 10
Screw compressor	<ul style="list-style-type: none"> Protection against inversion of direction of phase rotation Contact for automatic draining on stopping 	300	3 to 20
Piston compressor	<ul style="list-style-type: none"> Protection against inversion of direction of phase rotation Contact for automatic emptying on stopping 	350	5 to 10
Conveyor, transporter	<ul style="list-style-type: none"> Overload control for detecting faults or underload control for detecting breaks 	300	3 to 10
Lifting screw	<ul style="list-style-type: none"> Overload control for detecting hard spots or underload control for detecting breaks 	300	3 to 10
Drag lift	<ul style="list-style-type: none"> Overload control for detecting jamming or underload control for detecting breaks 	400	2 to 10
Lift	<ul style="list-style-type: none"> Overload control for detecting jamming or underload control for detecting breaks Constant starting with variable load 	350	5 to 10
Agitator	<ul style="list-style-type: none"> The current display indicates the density of the product 	350	5 to 20
Mixer	<ul style="list-style-type: none"> The current display indicates the density of the product 	350	5 to 10
Refiner	<ul style="list-style-type: none"> Torque control on starting and stopping 	300	5 to 30

Standard/ Severe Applications

Type of machine	Functions performed by the ATS48	Starting current (%In)	Starting time (s)
Fan	<ul style="list-style-type: none"> Detection of overloads caused by clogging or underloads (motor fan transmission broken) Braking torque on stopping 	300	10 to 40
Centrifugal compressor	<ul style="list-style-type: none"> Protection against inversion of direction of phase rotation Contact for automatic emptying on stopping 	350	10 to 40
Circular saw, band saw	<ul style="list-style-type: none"> Braking for fast stop 	300	10 to 60

Severe Applications

Type of machine	Functions performed by the ATS48	Starting current (%In)	Starting time (s)
Pulper, butchery knife	<ul style="list-style-type: none"> Torque control on starting 	400	3 to 10
Grinder	<ul style="list-style-type: none"> Braking to limit vibrations during stopping, overload control to detect jamming 	450	5 to 60
Crusher	<ul style="list-style-type: none"> Braking to limit vibrations during stopping, overload control to detect jamming 	400	10 to 40
Press	<ul style="list-style-type: none"> Braking to increase the number of cycles 	400	20 to 60

Special uses

Contact Seneca Enclosed Drives TAG for additional application information and pricing for those applications requiring:

- Two-speed or delta-wye motors. The ATS48 soft starter can operate with a 2-speed motor. A motor demagnetizing period must elapse before changing from low speed to high speed in order to avoid anti-phase between the line supply and the motor, which would generate very high currents.
- Motors other than NEMA® Design B
- High efficiency motors
- Low slip motors
- Power factor correction capacitors. Do not connect power factor correction capacitors to the terminals of a motor controlled by an ATS48 soft starter. The power factor capacitors must be controlled and connected to a line side contactor sequenced by the ATS48 at end of starting.
- Controller oversizing of more than 50%
- Non-standard trip characteristics
- Modifications not listed in this pricing guide
- Horsepower greater than those listed in this pricing guide
- Long motor cable lengths. Very long motor cables cause voltage drops due to the resistance of the cable. If the voltage drop is significant, it could affect the current consumption and the torque available. This criterion must be taken into account when selecting the motor and the starter.
- Miscellaneous application precautions. Do not use the ATS48 controller upstream of loads other than motors (i.e., transformers and resistance type loads)

Altistart 48

soft starters for asynchronous motors

Enclosed Altistart 48

Selection table

Selection Table

The following table assists in selecting an Enclosed Altistart 48 controller based on the voltage supply, horsepower rating, and frame size requirements for your specific application. For the complete list of criteria needed to make your selection, navigate to page 45 using the "Selection Criteria" button to the left.

To access detailed CAD drawings of a specific Enclosed Altistart 48 configuration, use the "CAD Drawings" button to the left.

Enclosed Altistart 48

Class 8638 and 8639 Enclosed Altistart 48						Weights & Dimensions								
Frame size	Power indicated on motor rating plate				Nominal motor current factory setting I_n A	Type 1 enclosure			Type 2 enclosure			Type 3R enclosure		
	208 V	230 V	460 V	575 V		Power Circuit N Non-reversing w/ isolation contactor	Power Circuit R Reversing w/ isolation contactor	Power Circuit S Shunt trip coil w/ molded case	Power Circuit N Non-reversing w/ isolation contactor	Power Circuit R Reversing w/ isolation contactor	Power Circuit S Shunt trip coil w/ molded case	Power Circuit N Non-reversing w/ isolation contactor	Power Circuit R Reversing w/ isolation contactor	Power Circuit S Shunt trip coil w/ molded case
	HP	HP	HP	HP										
A	3	5	10	15	14	33.43"H x 24.69"W x 13.083"D – 110 lbs.			33.43"H x 24.69"W x 13.083"D – 110 lbs.			33.43"H x 24.69"W x 13.083"D – 110 lbs.		
A	5	7.5	15	20	21									
A	7.5	10	20	25	27									
A	10	-	25	30	34									
A	-	15	30	40	40									
B	15	20	40	50	52	45.81"H x 18.69"W x 13.083"D – 125 lbs.			45.81"H x 18.69"W x 13.083"D – 125 lbs.			45.81"H x 18.69"W x 13.083"D – 125 lbs.		
B	20	25	50	60	65									
B	25	30	60	75	77									
B	30	40	75	100	96									
C	40	50	100	125	124	62.43"H x 18.69"W x 13.083"D – 200 lbs.			62.43"H x 18.69"W x 13.083"D – 200 lbs.			62.43"H x 18.69"W x 13.083"D – 200 lbs.		
C	50	60	125	150	156									
D	60	75	150	200	180	94.6"H x 30"W x 20"D – 500 lbs.	94.6"H x 30"W x 20"D – 500 lbs.	94.6"H x 20"W x 20"D – 400 lbs.	94.6"H x 30"W x 20"D – 500 lbs.	94.6"H x 30"W x 20"D – 500 lbs.	94.6"H x 20"W x 20"D – 400 lbs.	94.8"H x 37.7"W x 32.6"D – 525 lbs.	94.8"H x 37.7"W x 32.6"D – 525 lbs.	94.8"H x 27.7"W x 32.6"D – 425 lbs.
D	75	100	200	250	240	94.6"H x 35"W x 20"D – 750 lbs.	94.6"H x 55"W x 20"D – 1000 lbs.	94.6"H x 35"W x 20"D – 750 lbs.	94.6"H x 35"W x 20"D – 750 lbs.	94.6"H x 55"W x 20"D – 1000 lbs.	94.6"H x 35"W x 20"D – 750 lbs.	94.8"H x 42.7"W x 32.6"D – 800 lbs.	94.8"H x 62.7"W x 32.6"D – 1050 lbs.	94.8"H x 42.7"W x 32.6"D – 800 lbs.
D	100	125	250	300	302									
E	125	150	300	350	361									
E	150	-	350	400	414	94.6"H x 35"W x 20"D – 750 lbs.	94.6"H x 55"W x 20"D – 1000 lbs.	94.6"H x 35"W x 20"D – 750 lbs.	94.6"H x 35"W x 20"D – 750 lbs.	94.6"H x 55"W x 20"D – 1000 lbs.	94.6"H x 35"W x 20"D – 750 lbs.	94.8"H x 42.7"W x 32.6"D – 800 lbs.	94.8"H x 62.7"W x 32.6"D – 1050 lbs.	94.8"H x 42.7"W x 32.6"D – 800 lbs.
E	-	200	400	500	477									
E	200	250	500	600	660									

Altistart 48

soft starters for asynchronous motors

Enclosed Altistart 48

Options

8639 48U C G 4 S A06 A07 B08 A09 A10
 - 1 2 3 4 5 6 7 8 9 10

Class

- Controller class
 - 8638 = Fusible disconnect
 - 8639 = Circuit breaker disconnect

Type

- 1 Controller style**
48U = Enclosed Altistart 48 Soft Starter Controller
- 2 Horsepower rating**

A = 3 hp	J = 40 hp	S = 250 hp
B = 5 hp	K = 50 hp	T = 300 hp
C = 7.5 hp	L = 60 hp	U = 350 hp
D = 10 hp	M = 75 hp	W = 400 hp
E = 15 hp	N = 100 hp	X = 500 hp
F = 20 hp	P = 125 hp	Z = 600 hp
G = 25 hp	Q = 150 hp	
H = 30 hp	R = 200 hp	
- 3 Enclosure type**
 - G = UL Type 1 general purpose
 - A = UL Type 12K industrial use, dust/drip tight
 - H = UL Type 3R outdoor use
- 4 Voltage**

2 = 208 V ac	4 = 460 V ac
3 = 230 V ac	5 = 575 V ac
- 5 Power circuit options**
 - S = Shunt trip coil
 - N = Non-reversing with isolation contactor
 - R = Reversing with isolation contactor

Mods

- 6 Control options**
 - A06 = Start/stop pushbuttons
 - B06 = Forward, stop, and reverse pushbuttons
 - C06 = Hand-off-auto (HOA) selector switch
 - D06 = Stop-run selector switch
 - E06 = Hand-auto selector switch, start/stop pushbuttons
- 7 Pilot light clusters**
 - A07 = Run (red), off (green)
 - B07 = Push-to-test run (red), push to-test off (green)
 - C07 = Run (red), off (green), detected fault (yellow)
 - D07 = Push-to-test run (red), off (green), push-to-reset fault (yellow)
- 8 Metering options**
 - A08 = Ammeter
 - B08 = Elapsed run time meter
- 9 Communication cards**
 - A09 = Modbus™
 - C09 = Ethernet TCP/IP
 - D09 = Devicenet™
 - E09 = Ethernet IP
- 10 Miscellaneous options**
 - * The complete list of Miscellaneous options is located on pages 50 & 51.

Control options

A06	Start/Stop push buttons Provides black start and red stop push buttons (3-wire control scheme). Rule: Not available on Power Circuit R (reversing)
B06	Forward-Stop-Reverse selector switch Provides three-position selector switch to select between forward, off, and reverse. Uses 2-wire control. Rule: Available for Power Circuit R (reversing) configurations only
C06	Hand-Off-Auto selector switch Provides a three-position selector switch, 2-wire control scheme. Rule: Not available on Power Circuit R (reversing)
D06	Stop-Run selector switch Provides a two-position selector switch. Rule: Not available on Power Circuit R (reversing)
E06	Hand-Auto selector switch and Start/Stop push buttons Provides a two-position selector switch and start/stop push buttons (3-wire control) Rule: Not available on Power Circuit R (reversing)

Pilot light cluster options

A07	Pilot light cluster #1 Consists of red "RUN" and green "OFF" pilot lights. Provides standard red "RUN (ON)" and green "OFF" pilot lights for status annunciation.
B07	Pilot light cluster #2 Consists of red "RUN" (push-to-test) and green "OFF" (push-to-test) pilot lights. Provides push-to-test type red "RUN (ON)" and standard green "OFF" pilot lights for status annunciation.
C07	Pilot light cluster #3 Consists of red "RUN", green "OFF" and yellow "FAULT" pilot lights. Provides standard red "RUN (ON)", green "OFF" and yellow "FAULT" pilot lights for status annunciation. Rule: Not available with Power Circuit S (Shunt Trip)
D07	Pilot light cluster #4 Consists of red "RUN (ON)" (push-to-test), green "OFF" (push-to-test) and yellow "FAULT" (push-to-reset) pilot lights. Provides push-to-test type red "RUN (ON)", standard green "OFF", and push-to-reset type yellow "FAULT" for status annunciation. Rule: Not available with Power Circuit S (Shunt Trip)

Meter display options

A08	Ammeter Provides a single-phase ammeter fed from the Altistart 48 analog output. Dial is in percent of device rated current. Rule: Not available on Type 3R Enclosures
B08	Elapsed time meter Provides a seven-digit analog, non-resettable elapsed run time meter. Rule: Not available on Type 3R Enclosures

Altistart 48

soft starters for asynchronous motors

Enclosed Altistart 48

Options

8639 48U C G 4 S A06 A07 B08 A09 A10
 - 1 2 3 4 5 6 7 8 9 10

Class

- Controller class
- 8638 = Fusible disconnect
- 8639 = Circuit breaker disconnect

Type

- 1 Controller style**
48U = Enclosed Altistart 48 Soft Starter Controller
- 2 Horsepower rating**

A = 3 hp	J = 40 hp	S = 250 hp
B = 5 hp	K = 50 hp	T = 300 hp
C = 7.5 hp	L = 60 hp	U = 350 hp
D = 10 hp	M = 75 hp	W = 400 hp
E = 15 hp	N = 100 hp	X = 500 hp
F = 20 hp	P = 125 hp	Z = 600 hp
G = 25 hp	Q = 150 hp	
H = 30 hp	R = 200 hp	
- 3 Enclosure type**
G = UL Type 1 general purpose
A = UL Type 12K industrial use, dust/drip tight
H = UL Type 3R outdoor use
- 4 Voltage**

2 = 208 V ac	4 = 460 V ac
3 = 230 V ac	5 = 575 V ac
- 5 Power circuit options**
S = Shunt trip coil
N = Non-reversing with isolation contactor
R = Reversing with isolation contactor

Mods

- 6 Control options**
A06 = Start/stop pushbuttons
B06 = Forward, stop, and reverse pushbuttons
C06 = Hand-off-auto (HOA) selector switch
D06 = Stop-run selector switch
E06 = Hand-auto selector switch, start/stop pushbuttons
- 7 Pilot light clusters**
A07 = Run (red), off (green)
B07 = Push-to-test run (red), push to-test off (green)
C07 = Run (red), off (green), detected fault (yellow)
D07 = Push-to-test run (red), off (green), push-to-reset fault (yellow)
- 8 Metering options**
A08 = Ammeter
B08 = Elapsed run time meter
- 9 Communication cards**
A09 = Modbus™
C09 = Ethernet TCP/IP
D09 = Devicenet™
E09 = Ethernet IP
- 10 Miscellaneous options**
* The complete list of Miscellaneous options is located on pages 50 & 51.

Communications cards

Factory installed communication features shall be available as a custom engineered option utilizing the RJ45 communications port for control and annunciation of the soft starter in "link" mode

A09	Modbus™ Provides Modbus communications (native protocol)
C09	Ethernet TCP/IP Provides Ethernet gateway communications protocol.
D09	DeviceNet™ Provides DeviceNet gateway communications protocol.
E09	Ethernet IP Provides Ethernet IP gateway communications protocol.

Miscellaneous options

Mod A10	Full voltage bypass (AC3) Provides an AC3 duty rated bypass/shorting contactor, normal/bypass selector switch, Class 20 bi-metal motor OL relay, door mounted OL reset push-button for across the line starting capability. Rule: Only available for Power Circuit N (Non-Reversing). Not available with Power Circuit S (Shunt Trip) SCR fault isolation scheme.
B10	150 VA additional control power capacity Provides 150 VA additional control VA capacity for customer use.
C10	Power up ON delay (start relay) Provides an electronic time delay relay adjustable from 0.1 to 60 seconds. Relay is pre-wired to inhibit start for users to set delay time upon power-up of control.
D10	Emergency stop push button Provides a push-button for immediate removal of power.
E10	"cUL" label Provides a Canadian Underwriters Laboratories label when required by local code requirements.
F10	Auxiliary contacts for run mode Provides 1 Form 'C' contact rated 5 A @ 120 Vac (8501 Type R relay or equivalent) wired to terminal blocks for customer use. Contacts change state when soft starter is sending current to the motor. Controlled by the R3 relay programmed for "rnl".
G10	Auxiliary contacts for full voltage bypass run mode Provides 1 Form 'C' contact rated 5 A @ 120 Vac (8501 Type R relay or equivalent) wired to terminal blocks for customer use. Contacts change state when motor is operated across the line with full voltage bypass starter. Rule: MOD A10 (Full Voltage Bypass) must be selected. Must use Power Circuit N or R (line isolation contactor combination). Not compatible with Power Circuit S (Shunt Trip).
H10	Auxiliary contacts for auto mode Provides an auxiliary starter mode (auto) contact that will energize a relay with 1 Form 'C' contact rated 5 A @ 120 Vac (8501 Type R relay or equivalent) wired to terminal blocks for customer use. Rule: MOD C06 (Hand-Off-Auto selector switch) or E06 (Hand-Auto selector switch) must be specified.
J10	Auxiliary contacts for detected fault mode Provides an auxiliary starter mode (auto) contact that will energize a relay with 1 Form 'C' contact rated 5 A @ 120 Vac (8501 Type R relay or equivalent) wired to terminal blocks for customer use.

*Miscellaneous options are continued on the next page

Altistart 48

soft starters for asynchronous motors

Enclosed Altistart 48

Options

8639 48U C G 4 S A06 A07 B08 A09 A10
 - 1 2 3 4 5 6 7 8 9 10

Class

- Controller class
 - 8638 = Fusible disconnect
 - 8639 = Circuit breaker disconnect

Type

- 1 Controller style**
48U = Enclosed Altistart 48 Soft Starter Controller
- 2 Horsepower rating**

A = 3 hp	J = 40 hp	S = 250 hp
B = 5 hp	K = 50 hp	T = 300 hp
C = 7.5 hp	L = 60 hp	U = 350 hp
D = 10 hp	M = 75 hp	W = 400 hp
E = 15 hp	N = 100 hp	X = 500 hp
F = 20 hp	P = 125 hp	Z = 600 hp
G = 25 hp	Q = 150 hp	
H = 30 hp	R = 200 hp	
- 3 Enclosure type**
 - G = UL Type 1 general purpose
 - A = UL Type 12K industrial use, dust/drip tight
 - H = UL Type 3R outdoor use
- 4 Voltage**

2 = 208 V ac	4 = 460 V ac
3 = 230 V ac	5 = 575 V ac
- 5 Power circuit options**
 - S = Shunt trip coil
 - N = Non-reversing with isolation contactor
 - R = Reversing with isolation contactor

Mods

- 6 Control options**
 - A06 = Start/stop pushbuttons
 - B06 = Forward, stop, and reverse pushbuttons
 - C06 = Hand-off-auto (HOA) selector switch
 - D06 = Stop-run selector switch
 - E06 = Hand-auto selector switch, start/stop pushbuttons
- 7 Pilot light clusters**
 - A07 = Run (red), off (green)
 - B07 = Push-to-test run (red), push to-test off (green)
 - C07 = Run (red), off (green), detected fault (yellow)
 - D07 = Push-to-test run (red), off (green), push-to-reset fault (yellow)
- 8 Metering options**
 - A08 = Ammeter
 - B08 = Elapsed run time meter
- 9 Communication cards**
 - A09 = Modbus™
 - C09 = Ethernet TCP/IP
 - D09 = Devicenet™
 - E09 = Ethernet IP
- 10 Miscellaneous options**
 - * The complete list of Miscellaneous options is located on pages 50 & 51.

Miscellaneous options (continued)

L10	ID engraved nameplates Provides a lamacoid nameplate, engraved with equipment designation.
M10	Spare terminal blocks Provides up to (10) spare terminal blocks 'unwired' for customer use. Since Phoenix style terminal blocks will be used, extra terminal points will be provided as standard. 20 terminal points are available as standard for all control wiring (including any additional customer spare terminal points).
P10	Permanent wire markers Provides a permanent sleeve type wire marker on control wiring assemblies
Q10	ANSI #61 enclosure paint (custom engineered option) Provides the option to configure the enclosure paint scheme to standard ANSI #61 paint instead of ANSI #49 paint.
R10	MOV/Surge arrestor (custom engineered option) Provides supplementary MOV protection using a Class 6671 SDSA3650 Surge-breaker™ secondary surge arrestor hard-wired and factory mounted.
S10	Dual motor overloads and branch circuit protection (custom engineered option) Provides dual-rated motor OLS rated equally, one-half the HP of the selected starter. Motor branch short circuit protection is provided per NEC™. Maximum total current rating of the combined motors not to exceed the continuous current rating of the starter package. Rule: Available on Class 8639 circuit breaker disconnect configurations only.
U10	Omit door mounted keypad display Removes the keypad display from outside the enclosure door. The keypad on the Altistart 48 can be used for programming and commissioning. Rule: Only for Type 3R size D and E enclosures.
V10	OSHPD seismic qualification Provides special labels and documents to comply with the seismic requirements of the California Office of Statewide Planning and Development (OSHPD).
W10	NEMA® style contactors (custom engineered option) Provides horsepower rated NEMA rated contactors instead of AC3 rated IEC TeSys™ or F-line contactors.
X10	122 °F, 50 °C operation Provides extended range high ambient equipment rating above 104 °F (40 °C) to a maximum of 122 °F (50 °C) without de-rating. Rule: Standard on Type 3R enclosures
Y10	Seismic qualification label Provides a self-certified identification label with compliance to 2000 IBC, NFPA™ 5000, 2001 CBC, 1997 UBC, 1999 NBC, 1999SBC, ASCE-7 02 seismic qualification/certification. The label criteria will be uniform for all enclosed products. Enclosures shall contain additional bracing as defined by the seismic qualification/certification criteria. Rule: Not available for Enclosure Sizes A–C (wall mounted enclosures)
Z10	Service Entrance Rating Provides a UL869A approved insulated ground neutral lug assembly, mounting bracket with bonded enclosure ground wire suitable for use as service entrance equipment. Rule: Service Entrance Rating is only available for Type 3R enclosures and is not available with the Model E10 (cUL Label).
610¹	100K circuit breaker rating Only available: 208 V, 125–200 hp 230 V, 150–250 hp 460 V, 300–500 hp

(1) Only available for 208 V, 125 - 200 HP; 230 V, 150 - 250 HP; and 460V, 300 - 500 HP.



Quality Assurance Procedures

This document provides information regarding the quality assurance processes and procedures that are in place for the manufacturing of Altistart 48 (ATS48) soft-start/soft-stop units. Schneider Electric utilizes quality assurance processes and procedures to verify the integrity of components and the assembly process. This document provides a summary of these processes and procedures.



Outline of Test Process and Procedures

Data is gathered on each unit and tracked via the unique serial number of each unit. Test during production validates all electrical and software parameters. Final verification sample testing is conducted at various points in the manufacturing process for each soft starter. Test sampling size is 1 commercial reference per size per week.

In addition to the processes and procedures detailed above, the ISO certified manufacturing facility test stations have instructions for visual quality checks and electrical inspection. The visual quality check list includes a physical inspection for proper connections, proper assembly torques, mechanical integrity and proper documentation.

The quality assurance procedures detailed above are in place for the manufacturing of Altistart 48. These procedures are established to monitor and confirm the quality of the product line that has been designed in from the outset.

- ☑ Individual unit data tracked by unique serial number
- ☑ Electrical parameters
- ☑ Software parameters
- ☑ Final verification sample testing
- ☑ ISO certified visual quality checks
 - ☑ Proper connections
 - ☑ Proper assembly torques
 - ☑ Mechanical integrity
 - ☑ Proper documentation

This page was intentionally left blank.



Solutions for every stage of your equipment's life cycle

Schneider Electric™ provides services far beyond meeting your immediate needs for application or equipment repair. We take a long-term, holistic approach to determine your facility and operational needs and develop a strategy for improving the performance of your people, systems, and processes.

Schneider Electric provides services from system design and consulting, to maintenance support, modernization of your installation, and project delivery. Schneider Electric provides the people, tools, and processes to help maximize your business's infrastructure.

Our expertise enables you to cut costs, reduce energy consumption, and keep your systems up and running through routine maintenance, added enhancements, and migrations to new state-of-the-art functionality.

> Start-up and commissioning

Expert installation support to provide assistance in the start-up of your new system. Service includes a comprehensive power-up and diagnostic check on system components to minimize risk and optimize operation.

> Technical training

Training offered on-site, off-site, or online for Schneider Electric automation products taught by professional instructors with up-to-date knowledge of our latest hardware and software.

> Remote technical support

Comprehensive online and phone support from experts specially trained on Schneider Electric drive products, helping to reduce downtime and costs and optimize your system's life cycle.

> On-site technical support

Support service to perform regular maintenance, upgrades, and conversion assistance, small application and programming assistance, on-the-job training, equipment repair, support and troubleshooting, even in emergency situations.

> Preventative maintenance

Maintenance programs to scan for, and proactively detect, potential issues or problems with your automation system to help you avoid the costs of unscheduled downtime and short equipment service life. Also serves to extend the life of your installed base by using our services to properly maintain your equipment.

> Industrial repair services

Repair capabilities for over 400,000 part numbers from more than 2,500 manufacturers at our Greensboro, NC repair facility. Repair is available for both Schneider Electric and non-Schneider Electric equipment.

> Spare parts management

Save money and reduce downtime through our parts management program. An on-site assessment is performed to determine parts and inventory levels needed to ensure proper system operation and reduce downtime and inventory costs.

> Migration and modernization

Realize the productivity benefits of the latest Schneider Electric automation technology by using our assessment tools to identify and implement replacement of your legacy automation products, regardless of brand. We make extensive use of existing hardware and wiring for a cost-effective solution with minimal downtime.

> Software renewals

Access the latest software, firmware, and custom options to ensure you always have the latest functionality available to optimize your system's life cycle.

> Extended warranty

Extend your Schneider Electric standard manufacturer warranty from one year to five years. Protection plans are tailored to your needs reducing costs and out-of-service time.

> When it comes to your automation equipment, we can help you

- Increase productivity
- Improve reliability and safety
- Mitigate risk and limit downtime
- Keep equipment up to date
- Extend the life of your installed base
- Cut costs and increase savings
- Improve your return on investment

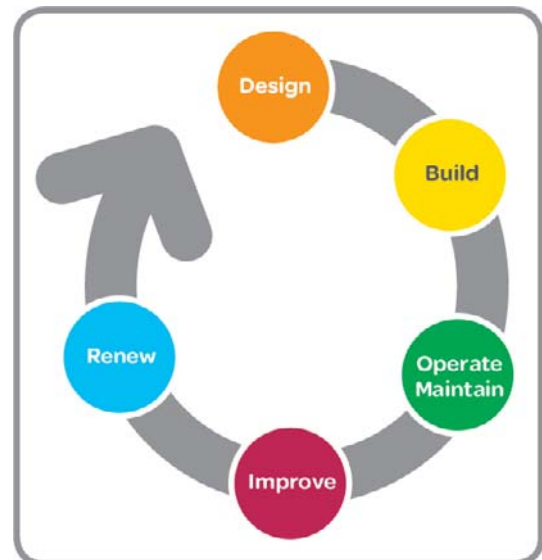

Talk to someone you can trust

The Altivar family of variable speed AC drives and the Altistart family of soft starters presents the most advanced and user-friendly solutions in the marketplace. Featuring proprietary motor control algorithms to achieve optimal reaction times and complete scalability to match your application requirements for speed, size, and protection, the complete line of Altivar and Altistart products provides the flexibility and performance to:

- Meet the needs of a broad range of industries, including HVAC, pump, material handling, hoisting, packaging and many more.
- Reduce your energy costs using proprietary energy-saving technologies available only from Schneider Electric.
- Improve your up-time by simplifying installation, commissioning and maintenance by providing advanced diagnostics, industry-leading voltage ride thru capability and seismic qualified products.

We also work with you to deliver the benefits of a global service and support of a global service and support organization to further increase the value of working with Schneider Electric. Our product specialists, industry experts, distributors, partners, and the countless other members of the Schneider Electric family are dedicated to helping you make the most of your energy everyday. Contact your local sales representative today to learn how Schneider Electric can improve operational performance and help your business to achieve a competitive advantage. Or visit www.schneider-electric.com

>Drive Product Support Group

For support and assistance, contact the Drive Product Support Group. The Drive Product Support Group is staffed from 8:00 am until 6:00 pm Eastern time to assist with product selection, start-up, and diagnosis of product or application problems.

EMERGENCY Technical phone support is available 24 hours a day, 365 days a year.

Toll Free **1-888-778-2733**

E-mail **drive.products.support@us.schneider-electric.com**

Fax **919-217-6508**

>Schneider Electric Service (On-Site)

The Schneider Electric Services division is committed to providing quality on-site service that consistently meets customer expectations. Services responds to your requests, seven days a week, 24 hours a day.

Phone **1-888-778-2733**

>Schneider Electric Customer Training

Schneider Electric offers a variety of instructor-led skill enhancing and technical product training programs for customers. For a complete list of drives/soft starter training with dates, locations, and pricing please call:

Phone **978-975-9306**

Fax **978-975-2821**

>Customer Care Center

(Assist with stock checks, assist with claims, and assist with order management issues)

To provide additional support, Schneider Electric has rolled out new Technical Service Representatives in local offices which have the strongest needs.

Due to time zone changes and different time operation requirements business operation times vary.

Phone **888-778-2733**

Fax **888-329-9773**



Schneider Electric USA, Inc.

Schneider Electric USA, Inc.
8001 Knightdale Blvd.
Knightdale, NC 27545

USA Customer Care Center
Tel: 888-778-2733

© 2014 Schneider Electric. All rights reserved. Schneider Electric, Altistart, SoMove, Modbus, TeSys, and Surgebreaker are trademarks owned by Schneider Electric Industries SAS or its affiliated companies. All other trademarks are the property of their respective owners.

The information provided in this documentation contains general descriptions and/or technical characteristics of the performance of the products contained herein. This documentation is not intended as a substitute for and is not to be used for determining suitability or reliability of these products for specific user applications. It is the duty of any such user or integrator to perform the appropriate and complete risk analysis, evaluation and testing of the products with respect to the relevant specific application or use thereof. Neither Schneider Electric nor any of its affiliates or subsidiaries shall be responsible or liable for misuse of the information contained herein.

Design: Schneider Electric
Photos: Schneider Electric

8661CT1403
August 2014 - V1.0