

Catalog
Extract
LV 10

Edition
10/2023

SENTRON • SIVACON • ALPHA

Low-Voltage Power Distribution and Electrical Installation Technology

Miniature Circuit Breakers

[siemens.com/lowvoltage](https://www.siemens.com/lowvoltage)

Innovative solutions for industrial controls and power distribution

Reliable components and systems are essential in ensuring smooth power distribution in buildings and industrial plants.

With SIRIUS, SENTRON, SIVACON and ALPHA, we offer an innovative portfolio for standard-compliant and demand-oriented applications.

Efficient engineering tools and innovative cloud-based solutions can be flexibly tailored to individual requirements.

We are there when you need us

Your personal contact can be found at
www.siemens.com/lowvoltage/contact

Catalog LV 10 · 10/2023

You will find the latest edition and all future editions in SiePortal at www.siemens.com/lowvoltage/catalogs

You can find the current prices in SiePortal at www.siemens.com/lowvoltage/product-catalog



The products and systems described in this catalog are manufactured/distributed under application of a certified quality management system in accordance with EN ISO 9001 (for the Certified Registration Nos., see www.siemens.com/system-certificates/ep). The certificate is recognized by all IQNet countries.

Technical specifications

The technical specifications are for general information purposes only. Always heed the operating instructions and notices on individual products during assembly, operation and maintenance.

All illustrations are not binding.

© Siemens 2023

Low-Voltage Power Distribution and Electrical Installation Technology

	Introduction	1/2	I
Protecting	Air Circuit Breakers	1/1	1
	Molded Case Circuit Breakers	2/1	2
	Miniature Circuit Breakers	3/1	3
	Residual Current Protective Devices/Arc Fault Detection Devices (AFDDs)	4/1	4
	Switching Devices	5/1	5
	Overvoltage Protection Devices	6/1	6
	Fuse Systems	7/1	7
Protecting, Switching and Isolating	Switch Disconnectors	8/1	8
Switching and Isolating	Transfer Switching Equipment and Load Transfer Switches	9/1	9
Measuring and Monitoring	Measuring Devices, Power Monitoring and Digitalization Solutions	10/1	10
	Monitoring Devices	11/1	11
Distribution	Transformers, Power Supply Units and Socket Outlets	12/1	12
	Busbar Systems	13/1	13
	Terminal Blocks	14/1	14
	Switchboards, Distribution Boards and Small Distribution Boards	15/1	15
	Busbar Trunking Systems	16/1	16
	System Cubicles, System Lighting and System Air-Conditioning	17/1	17
	Appendix	A/1	A



Protecting electrical installations from damage

The number of electrical loads is constantly increasing, which places an ever greater load on the electrical installation.

In the event of an overload or short-circuit, miniature circuit breakers safely cut off the connected circuit and reliably protect electrical installations and equipment from damage. Miniature circuit breakers with communication and measuring function create transparency right down to the final circuit and increase system availability.

Miniature circuit breakers from the SENTRON portfolio are also simple to mount and install. The devices have a uniform design and, with the appropriate accessories, can be expanded by many additional functions.

For industry, buildings or infrastructure – with our versatile portfolio, you will find a suitable miniature circuit breaker for any application.

Miniature Circuit Breakers

All the information you need	3/2
Devices for all applications	3/4
System overview	3/5
Quick selection guide	3/6
Miniature circuit breakers	3/6
Circuit breakers for equipment	3/10
Basic units	3/12
5SL3 miniature circuit breakers	3/12
5SL6 miniature circuit breakers	3/14
5SL4 miniature circuit breakers	3/16
5SJ6...-KS miniature circuit breakers	3/18
5SL30 miniature circuit breakers	3/20
5SL60 miniature circuit breakers	3/22
5SY6 miniature circuit breakers	3/24
5SY4 miniature circuit breakers	3/26
5SP4 miniature circuit breakers	3/28
5SP5 miniature circuit breakers	3/30
5SY5 miniature circuit breakers	3/32
5SY7 miniature circuit breakers	3/34
5SY8 miniature circuit breakers	3/36
5SJ4..HG.. miniature circuit breakers	3/38
5SL6 COM miniature circuit breakers with communication and measuring functions	3/40
5SP3 selective main miniature circuit breakers (SHU)	3/44
5SY17 circuit breakers for equipment	3/46
5SK9 circuit breakers for equipment	3/47
Accessories	3/48
Overview of the modular system	3/48
Electrical accessories	3/50
Mechanical accessories	3/60
Standard busbars	3/62
Compact busbars	3/73
Accessories for busbars	3/78
Distribution blocks for DIN-rail mounting	3/84
SIKclip wiring system	3/87

A multitude of additional information ...

Information + ordering

All the important things at a glance

For information about miniature circuit breakers, please visit our websites

www.siemens.com/mcb

www.siemens.com/circuit-protection

Your product in detail

The SiePortal platform (knowledge base) provides comprehensive information

www.siemens.com/lowvoltage/product-support

- Technology Primer
 - Miniature circuit breakers (109482304)

The relevant tender specifications can be found at

www.siemens.com/tenderspecifications

Use our conversion tool for quick and easy conversion to Siemens products www.siemens.com/conversion-tool

Siemens YouTube channel

- Miniature circuit breakers (general) sie.ag/59PC9j

Everything you need for your order

Refer to SiePortal to find an overview of your products (product catalog)

- Miniature circuit breakers sie.ag/41HWeiL

Direct forwarding to the individual products in SiePortal by clicking on the article number in the catalog or entering this web address incl. article number

www.siemens.com/product_catalog_SIEP?Article No.

The fast track to the experts

Contact persons in your region

We offer a comprehensive portfolio of services.

You can find your local contacts at

www.siemens.com/lowvoltage/components/contact

You will find further information on services at

www.siemens.com/service-offers

Competent expert advice on technical questions with a wide range of demand-optimized services for all our products and systems.

Assistance with technical queries is provided at

www.siemens.com/support-request

... can be found in our online services

Commissioning + operation

Your product in detail

The SiePortal platform (knowledge base) provides detailed technical information

www.siemens.com/lowvoltage/product-support

- Operating instructions
- Characteristic curves
- Certificates

Online Support app available for download from the [App Store](#) and [Play Store](#)

You will find further information at www.siemens.com/support-app

Provision of 3D data (step and u3d data formats)

- SiePortal (product catalog)
www.siemens.com/lowvoltage/product-catalog
- Image database
www.siemens.com/lowvoltage/picturedb

Engineering data for CAD or CAE systems are available in the CAx Download Manager at www.siemens.com/cax

Manuals

Manuals can be found in SiePortal at

www.siemens.com/lowvoltage/manuals

- Configuration Manual
 - Miniature circuit breakers ([45302792](#))
- Installation Manual
 - Circuit protection devices with communication and measuring function ([109791805](#))
- System Manual
 - Circuit protection devices with communication and measuring function ([109791806](#))

Face-to-face or online training

Our training courses can be found at

www.siemens.com/sitrain-lowvoltage

- SENTRON circuit protection devices with measuring and communication function (WT-LVBCOM)
- Basic principles of electrical engineering (WT-LVBGET)
- Protection concept (WT-LVBPC)

Technical overview – Miniature circuit breakers



The fast way to get you to our online services

This page provides you with comprehensive information and links on miniature circuit breakers

www.siemens.com/lowvoltage/product-support ([109769082](#))

Devices for all applications

Miniature circuit breakers for basic applications



Ideal for standard applications

The 5SL miniature circuit breakers are the new standard with B and C tripping characteristics for applications up to 63 A. They can be used as main control switches to disconnect or isolate equipment.

The 5SL devices are mainly installed in meter panels and small distribution boards to protect circuits for lamps, cookers and even machines, for example, in residential or commercial buildings.

Miniature circuit breakers for advanced applications



Ideal for industrial applications

For circuits with motors or large lamps, semiconductors or strong pulse-generating equipment such as transformers and solenoid valves – the 5SY and 5SP devices are optimized for industrial applications and are proven in use.

The 5SY devices offer you top quality and functionality for installation in complex buildings and industry. With a rated breaking capacity of up to 25 kA, they are able to handle the most challenging requirements at a rated current of 0.3 to 80 A.

Special features

- Dual-chamber terminals
- Simple to detach without tools using sliding catches
- Separate switching position indication
- A wide range of accessories
- 5SL60 available as communication-capable miniature circuit breaker

Circuit breakers for equipment for advanced applications



Ideal for devices in industry

Circuit breakers for equipment from Siemens offer optimum protection for all applications in AC and DC control circuits in industrial applications and plant engineering.

Thermomagnetic 5SY17 circuit breakers for equipment are used to protect solenoid valves, servo motors, signal lamps or even PLC inputs. Everywhere where loads have to be precisely protected from overloads and short-circuits.

Electronic 5SK9 circuit breakers for equipment are optimally suited to protecting, for example, relays, programmable controllers, motors, sensors, actuators and valves. A current analysis in conjunction with fast tripping in the event of a fault avoid the danger of overloading the switched-mode power supply.

5SL6 COM miniature circuit breakers and 5ST3 COM auxiliary switches/fault signal contacts with communication and measuring functions

The new communication-capable protective devices and auxiliary components record measured values and status information and transmit this data wirelessly to higher-level systems.

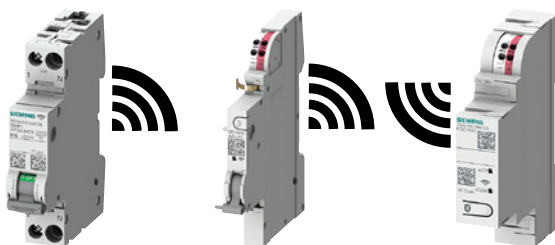

5SL6 COM

[see page 3/40](#)

5ST3 COM

[see page 3/54](#)

SETRON
Powercenter 1000

[see page 10/20](#)

- Recording of energy and active power, current, voltage, line frequency and temperature
- Measurement of residual currents in various frequency ranges
- Integrated status acquisition, operating hours counter and trip counter
- Higher system availability through early response to warning messages
- Convenient integration into new and existing systems thanks to compact mounting widths of 1 MW
- Fast parameterization and commissioning with the SENTRON Powerconfig mobile app or the SENTRON Powerconfig software
- Wireless transmission of measurement data from up to 24 communication-capable devices to the SENTRON Powercenter 1000 data transceiver

System overview

Basic units and accessories

Miniature circuit breakers for basic applications



5SL3

5SL6

5SL4

5SJ6...-KS

5SL30

5SL60

5SP3

Miniature circuit breakers for advanced applications



5SY6

5SY4

5SP4

5SP5

5SY5

5SY7

5SY8

5SJ4..HG..

5SL6 COM
(EM)5SL6 COM
(RCM/EM)

Circuit breakers for equipment for advanced applications

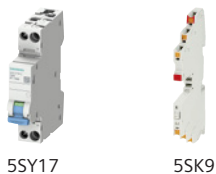

5SY17

5SK9

Electrical accessories

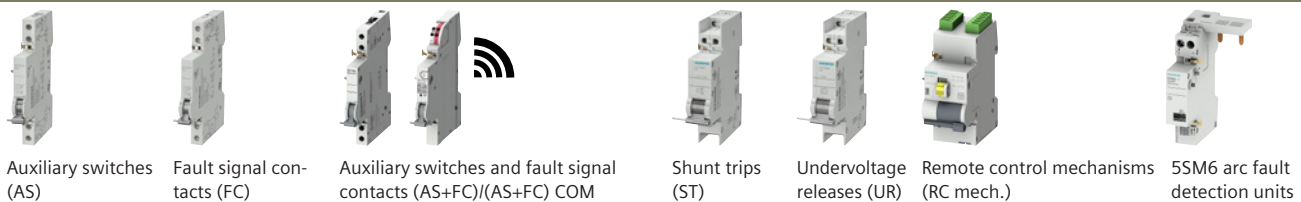
Auxiliary switches
(AS)Fault signal con-
tacts (FC)Auxiliary switches and fault signal
contacts (AS+FC)/(AS+FC) COMShunt trips
(ST)Undervoltage
releases (UR)Remote control mechanisms
(RC mech.)5SM6 arc fault
detection units

Mechanical accessories

Rotary operating
mechanisms

Spacers

Terminal covers

Wall enclosures

Molded-plastic
enclosuresHolders for front
panel installationIntermediate
frames

Busbars and accessories

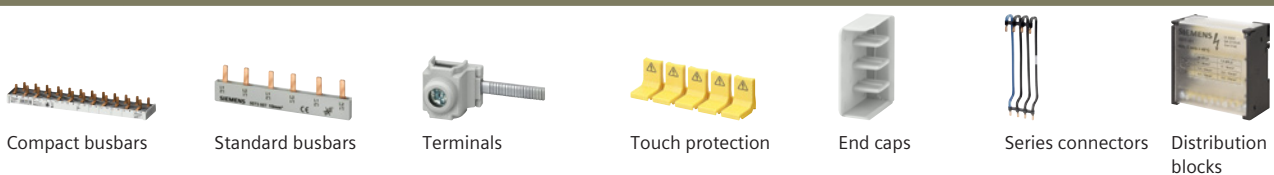

Compact busbars

Standard busbars

Terminals

Touch protection

End caps

Series connectors

Distribution
blocks

Note:

You will find a detailed range of accessories with the basic units and in the Accessories section.

Miniature circuit breakers

For basic applications for buildings and infrastructure



5SL3



5SL6

Standards			IEC/EN 60898-1	IEC/EN 60898-1
Standards			IEC/EN 60898-1	IEC/EN 60898-1
Basic data				
Breaking capacity I_{cn} for AC (230/400 V)	kA		4.5	6
Rated current	A		0.3 ... 63	0.3 ... 63
Number of poles			1P 2P 3P 4P 1P+N 3P+N	1P 2P 3P 4P 1P+N 3P+N
Tripping characteristic			B C	B C
Approvals				
General product approvals			VDE, CEBC, TSE	VDE, CEBC, TSE
Marine classifications			–	–
Voltage/frequency				
Rated voltage AC	V		230/400	230/400
Max. operational voltage AC	V		250/440	250/440
Rated voltage DC per phase pole	V		60	60
Max. operational voltage DC per phase pole	V		72 ¹⁾	72 ¹⁾
Rated impulse voltage U_{imp}	kV		4	4
Rated frequency f_n	Hz		50/60	50/60
Connection				
Dual-chamber terminal			–	–
Conductor cross-section 1 wire	Solid/stranded	mm ²	0.75 ... 35	0.75 ... 35
	Finely stranded with end sleeve	mm ²	0.75 ... 25	0.75 ... 25
	Finely stranded without end sleeve	mm ²	1 ... 35	1 ... 35
Conductor cross-section 2 wires (same cross-section and same conductor type)	Solid/stranded	mm ²	0.75 ... 10	0.75 ... 10
	Finely stranded with end sleeve	mm ²	0.75 ... 4	0.75 ... 4
	Finely stranded without end sleeve	mm ²	1 ... 4	1 ... 4
Conductor cross-section 1-wire + busbar (pin thickness 1.5 mm)	Solid/stranded	mm ²	10 ... 25	10 ... 25
	Finely stranded with non-insulated end sleeve	mm ²	6 ... 25	6 ... 25
	Finely stranded with insulated end sleeve	mm ²	6 ... 16	6 ... 16
Ambient conditions				
Ambient temperature ⁵⁾	°C		–25 ... +45 ²⁾	–25 ... +45 ²⁾
Storage temperature	°C		–40 ... +75 ⁴⁾	–40 ... +75 ⁴⁾
Shock acc. to IEC 60068-2-27 150 m/s ² at 11 ms half-sine			–	–
Resistance to vibrations acc. to IEC 60068-2-6: 5 ... 25 Hz (±1 mm) and at 25 ... 150 Hz (50 m/s ²)			–	–
Resistant to shock and vibrations acc. to EN 61373 and EN 50155 "1B" (railway engineering)			–	–
Fire behavior of materials acc. to EN 45545-2 (fire protection on railway vehicles)			–	–
Degree of pollution for overvoltage category			2/III	2/III
Further information				
			See page 3/12	See page 3/14

¹⁾ Except for characteristic C: 0.3 A ... 1 A and characteristic D: 0.3 A ... 2 A

²⁾ Periodically +55 °C, max. 95% humidity

³⁾ Max. 95% humidity

⁴⁾ Max. 85% rel. humidity, > 45 °C max. 0.056kg/m³ abs. humidity

⁵⁾ The device properties specified, for example, in the product standards, such as service life, breaking capacity and surface temperature, cannot be guaranteed at the specified ambient temperatures that lie outside the specified product standards.

**5SL4****5SJ6...-KS****5SL30****5SL60****5SP3**

5SL4	5SJ6...-KS	5SL30	5SL60	5SP3
IEC/EN 60898-1	IEC/EN 60898-1	IEC/EN 60898-1	IEC/EN 60898-1	DIN VDE 0641-21
10	6	4.5	6	25
0.3 ... 63	10 ... 20	2 ... 40	2 ... 40	16 ... 63
1P 2P 3P 4P 1P+N 3P+N	1P 2P 3P 1P+N	1P+N	1P+N	1P 2P 3P 4P
B C D	B C	C	B C	E
VDE, CEBC, IMQ	VDE	VDE, IMQ, NF, CCC	VDE, IMQ, NF, CCC	VDE
–	–	–	DNV-GL	–
230/400	230/400	230	230	230/400
250/440	250/440	250	250	250/440
60	60	60	60	–
72 ¹⁾	60	72 ¹⁾	72 ¹⁾	–
4	4	4	4	6
50/60	50/60	50/60	50/60	50/60
–	Plug-in terminal on outgoing side	–	–	–
0.75 ... 35	1.5 ... 4 (top) 0.75 ... 25 (bottom)	0.75 ... 16	0.75 ... 16	2.5 ... 50 (bottom)
0.75 ... 25	1.5 ... 2.5 (top) 0.75 ... 25 (bottom)	0.75 ... 10	0.75 ... 10	2.5 ... 50 (bottom)
1 ... 35	1.5 ... 4	0.75 ... 16	0.75 ... 16	2.5 ... 16 (top)
0.75 ... 10	–	0.75 ... 4	0.75 ... 4	–
0.75 ... 4	–	0.75 ... 1.5	0.75 ... 1.5	–
1 ... 4	–	0.75 ... 4	0.75 ... 4	–
10 ... 25	–	–	–	–
6 ... 25	–	6 ... 10	6 ... 10	–
6 ... 16	–	6 ... 10	6 ... 10	–
–25 ... +55 ³⁾	–25 ... +45 ²⁾	–25 ... +60 ⁴⁾	–25 ... +60 ⁴⁾	–25 ... +55
–40 ... +75 ⁴⁾	–40 ... +75 ⁴⁾	–40 ... +75	–40 ... +75	–40 ... +70
–	–	–	–	–
–	–	–	–	–
–	–	–	–	–
–	–	–	–	–
2/III	2/III	2/III	2/III	3/IV
See page 3/16	See page 3/18	See page 3/20	See page 3/22	See page 3/44

Miniature circuit breakers

For advanced applications for buildings and infrastructure and for industry and mechanical engineering



5SL6 COM

5SY6

5SY4

Standards

Standards	IEC/EN 60898-1	IEC/EN 60898-1 IEC/EN 60947-2 UL 1077	IEC/EN 60898-1 IEC/EN 60947-2 UL 1077
-----------	----------------	---	---

Basic data

Breaking capacity I_{cn}	For AC (230/400 V) acc. to IEC/EN 60898-1	kA	6	6	10	
	For DC (220/440 V) acc. to IEC/EN 60898-2	kA	–	–	–	
	Acc. to UL1077 and CSA C22.2 No.235		–	Supplementary protector, OC, FW 0, OL 0, TC 3 at 50 °C U2: see Certificate of Compliance	Supplementary protector, OC, FW 0, OL 0, TC 3 at 50 °C U2: see Certificate of Compliance	
Rated breaking capacity I_{cu}	Acc. to IEC/EN 60947-2 AC at U_e 230 V at U_e 400 V (1P, 1P+N) (2P, 3P, 4P, 3P+N)	I_n 0.3 ... 2 A	kA	–	30 30	35 35
		I_n 3 ... 6 A	kA	–	30 30	35 35
		I_n 8 ... 10 A	kA	–	15 15	20 20
		I_n 13 ... 32 A	kA	–	15 15	20 20
		I_n 35 ... 40 A	kA	–	10 10	15 15
		I_n 50 ... 63 A	kA	–	10 10	15 15
	I_n 80 ... 125 A	kA	–	– –	10 10	
	Acc. to IEC/EN 60947-2 DC at U_e 220 V at U_e 440 V (1P) (2P, 3P, 4P)	kA	–	–	–	
Rated current		A	2 ... 32	0.3 ... 63	0.3 ... 80	
Number of poles			1P+N	1P 2P 3P 4P 1P+N 3P+N	1P 2P 3P 4P 1P+N 3P+N	
Tripping characteristic			B C	B C	A B C D	

Approvals

General product approvals			VDE, RED	VDE, IMQ, CCC, 	VDE, IMQ, CCC,
Marine classifications			–	DNV-GL, LR, BV, RINA, ABS	DNV-GL, LR, BV, RINA, ABS

Voltage/frequency

Rated voltage AC		V	230	230/400	230/400
	Acc. to UL 489, UL 1077, CSA C22.2 No.235	V	–	277/480	277/480
Max. operational voltage AC		V	250	250/440	250/440
Rated voltage DC per phase pole		V	–	60	60
Max. operational voltage DC per phase pole		V	–	72 ¹⁾	72 ¹⁾
Rated impulse voltage U_{imp}		kV	4	4	4
Rated frequency f_n		Hz	50/60	50/60	50/60

Connection

Dual-chamber terminal			–	■	■
Conductor cross-section 1 wire	Solid/stranded	mm ²	0.75 ... 16	0.75 ... 35	0.75 ... 35
	Finely stranded with end sleeve	mm ²	0.75 ... 10	0.75 ... 25	0.75 ... 25
	Conductors (Cu 60/75 °C $I_n \leq 40$ A; 60 °C $I_n > 40$ A)		–	AWG 18 ... 4	AWG 18 ... 4
Terminal tightening torque		Nm	1.2 ... 2 max.	2.5 ... 3.5 max.	2.5 ... 3.5 max.
		lb-in	11 ... 18	22 ... 26	22 ... 26

Ambient conditions

Ambient temperature ⁷⁾		°C	–25 ... +60 ⁵⁾	–25 ... +55 ⁴⁾	–40 ... +70 ³⁾
Storage temperature		°C	–40 ... +75	–40 ... +75 ³⁾	–40 ... +75 ³⁾
Shock acc. to IEC 60068-2-27 150 m/s ² at 11 ms half-sine			–	■	■
Resistance to vibrations acc. to IEC 60068-2-6: 5 ... 25 Hz (± 1 mm) and at 25 ... 150 Hz (50 m/s ²)			–	■	■
Resistant to shock and vibrations acc. to EN 61373 and EN 50155 "1B" (railway engineering)			■	–	■
Fire behavior of materials acc. to EN 45545-2 (fire protection on railway vehicles)			■	–	■
Degree of pollution for overvoltage category			2/III	3/III	3/III

Additional functions

Communication and measuring function ⁸⁾			■	–	–
--	--	--	---	---	---

Further information

See page 3/40

See page 3/24

See page 3/26

¹⁾ Exempt: C/D 0.3 A ... 0.5 A

²⁾ 5SY54.. 4-pole, degree of pollution 2 for overvoltage category II

³⁾ 95% humidity up to 55 °C, 55% humidity up to 70 °C, 30% humidity up to 75 °C

⁴⁾ Max. 95% humidity

⁵⁾ Max. 85% rel. humidity, > 45 °C max. 0.056kg/m³ abs. humidity

⁶⁾ When used with a busbar at the front or 2 conductors, the terminal area at the rear is restricted, see notes on the Internet

**5SP4****5SP5****5SY5****5SY7****5SY8****5SJ4..HG..**IEC/EN 60898-1
UL 1077

IEC/EN 60947-2

IEC/EN 60898-2
UL 1077IEC/EN 60898-1
IEC/EN 60947-2
UL 1077IEC/EN 60947-2
UL 1077IEC/EN 60947-2
UL 489

10

-

10

15

25

-

-

-

10

-

-

-

Supplementary protector,
OC, FW 0, OL 0,
TC 3 at 50 °C

-

Supplementary protector,
OC, FW 0, OL 0,
TC 3 at 50 °CSupplementary protector,
OC, FW 0, OL 0,
TC 3 at 50 °CSupplementary protector,
OC, FW 0, OL 0,
TC 3 at 50 °C

-

U2: see Certificate of
Compliance

-

U2: see Certificate of
ComplianceU2: see Certificate of
ComplianceU2: see Certificate of
Compliance

-

-|-

-|-

-|-

50|50

70|70

10

-|-

-|-

-|-

40|40

50|50

10

-|-

-|-

-|-

30|30

40|40

10

-|-

-|-

-|-

25|25

30|30

10

-|-

-|-

-|-

20|20

25|25

10

-|-

-|-

-|-

15|15

20|20

10

10|10

-|-

-|-

-|-

-|-

-

-

10

15

-

-

-

80 ... 125

80 ... 125

0.3 ... 63

0.3 ... 63

0.3 ... 63

0.3 ... 63

1P|2P|3P|4P

1P|2P

1P|2P|4P

1P|2P|3P|4P|1P+N|
3P+N1P|2P|3P|4P|1P+N|
3P+N

1P|2P|3P

B|C|D

-

B|C

B|C|D

C|D

B|C|D

VDE, CCC,

LR

-

VDE, CCC,

ABSVDE, IMQ, CCC,

DNV-GL, LR, BV, RINA, ABS
ABSVDE, CCC,

-

230/400

-

230/400

230/400

230/400

230/400

277/480

-

-

277/480

277/480

240/415 (5SJ4..HG40/41)
277/480 (5SJ4..HG42)

250/440

-

250/440

250/440

250/440

250/440

60

220

220

60

60

60

72

250

250

72¹⁾72¹⁾

60

4

4

4

4

4

4

50/60

50/60

50/60

50/60

50/60

50/60

-

-

■

■

■

■

10 ... 50

10 ... 50

0.75 ... 35

0.75 ... 35

0.75 ... 35

0.75 ... 25 (16)⁶⁾

10 ... 35

10 ... 35

0.75 ... 25

0.75 ... 25

0.75 ... 25

0.75 ... 25 (10)

AWG 3 ... 1

AWG 3 ... 1

AWG 18 ... 4

AWG 18 ... 4

AWG 18 ... 4

AWG 18 ... 4 (5)

2.5 ... 3.5 max.

2.5 ... 3.5 max.

2.5 ... 3.5 max.

2.5 ... 3.5 max.

2.5 ... 3.5 max.

2.5 ... 3.5 max.

22 ... 31

22 ... 31

22 ... 26

22 ... 26

22 ... 26

22 ... 26

-25 ... +55⁴⁾-25 ... +55⁴⁾-40 ... +70³⁾-40 ... +70³⁾-25 ... +55⁴⁾-25 ... +55⁴⁾-40 ... +75³⁾-40 ... +75³⁾-40 ... +75³⁾-40 ... +75³⁾-40 ... +75³⁾-40 ... +75³⁾

-

-

■

■

-

■

■

-

■

■

■

■

-

-

■

■

-

-

■

-

■

■

-

-

3/III

3/III

3/III⁴⁾

3/III

3/III

3/III

-

-

-

-

-

-

See page 3/28

See page 3/30

See page 3/32

See page 3/34

See page 3/36

See page 3/38

⁷⁾ The device properties specified, for example, in the product standards, such as service life, breaking capacity and surface temperature, cannot be guaranteed at the specified ambient temperatures that lie outside the specified product standards.

⁸⁾ Please note the country-specific radio licenses of the products at www.siemens.com/lowvoltage/certificates (109801197)

Circuit breakers for equipment

For advanced applications for industry and mechanical engineering



5SY17

Standards

Standards	IEC/EN 60934 UL 1077
-----------	-------------------------

Basic data

Breaking capacity I_{cn}	At rated voltage	kA	3
Rated current		A	0.5 ... 16
Number of poles			1P+AS
DC tripping	Magnetic		F1 (2.5 ... 4 × I_n) F2 (4 ... 7 × I_n)
	Thermal		1.05 × holding current 1.35 × tripping current TC3 1.35 × I_n
	Electronic		–
Service life/endurance	Actuations		6000

Approvals

General product approvals	CCC, 
---------------------------	---

Voltage/frequency

Rated voltage AC	Acc. to IEC/DIN EN 60934	V	230
	Acc. to UL 1077	V	277
Min. operational voltage AC		V	12 ²⁾
Max. operational voltage AC		V	250
Rated voltage DC per phase pole		V	60
Min. operational voltage DC per phase pole		V	12 ²⁾
Max. operational voltage DC per phase pole		V	72
Rated impulse voltage U_{imp}		kV	4
Rated frequency f_n		Hz	50/60

Auxiliary switch

Min. operational voltage (AC)	V	12
Max. operational voltage (AC)	V	250
Min. operational voltage (DC)	V	12
Max. operational voltage (DC)	V	60
Utilization category AC-12		6 A at 230 V AC
Utilization category AC-14		6 A at 230 V AC
Utilization category DC-13		1 A at 60 V DC

Connection

Dual-chamber terminal			–
Conductor cross-section 1 wire	Solid/stranded	mm ²	0.75 ... 16
	Finely stranded with end sleeve	mm ²	0.75 ... 10
	Finely stranded with insulated end sleeve	mm ²	0.75 ... 10
	Finely stranded without end sleeve	mm ²	0.75 ... 16
	Conductor cross-section AWG		–
2-wire (same cross-section)	Solid/stranded	mm ²	0.75 ... 4
	Finely stranded with end sleeve	mm ²	0.75 ... 2.5
	Finely stranded with insulated end sleeve	mm ²	0.75 ... 1.5
	Finely stranded without end sleeve	mm ²	0.75 ... 4
Terminal tightening torque		Nm	2.0 ... 2.5 max.
		lb-in	17.7 ... 22.1

Ambient conditions

Ambient temperature	°C	–25 ... +60 ³⁾
Storage temperature	°C	–40 ... +70
Shock acc. to IEC 60068-2-27 150 m/s ² at 11 ms half-sine		–
Resistance to vibrations acc. to IEC 60068-2-6: 5 ... 25 Hz (±1 mm) and at 25 ... 150 Hz (50 m/s ²)		–
Resistant to shock and vibrations acc. to EN 61373 and EN 50155 "1B" (railway engineering)		■
Fire behavior of materials acc. to EN 45545-2 (fire protection on railway vehicles)		■
Degree of pollution for overvoltage category	Acc. to IEC	2/III

Further information

See page 3/46

¹⁾ Max. 95% humidity

²⁾ At a minimum current of 100 mA

³⁾ Max. 85% rel. humidity, > 45 °C max. 0.056 kg/m³ abs. humidity



5SK9

EN 61000-6-2, EN 61000-6-3, EN 60068-2-78,
EN 50178, EN 60068-2-6, EN 60068-2-27,
UL 508, UL 2367

–

1 ... 8

1P+AS

–

–

Overload $1.2 \times I_n/1s$ | Short-circuit $2 \times I_n / < 10\text{ ms}$

–



–

–

–

–

24

–

30

0.5

–

–

–

–

–

–

–

–

–

–

–

–

–

0.2 ... 4

0.2 ... 2.5

0.2 ... 2.5

–

AWG 24 ... 12

–

–

–

–

–

–

–

–25 ... +60¹⁾

–40 ... +70

–

–

–



–

–

[See page 3/47](#)

5SL3 miniature circuit breakers

4.5 kA

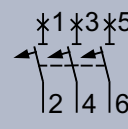
	1P	1P+N	2P	3P				
Rated voltage U_n	230/400 V AC	230 V AC	400 V AC	400 V AC				
Mounting width	1 MW 	2 MW 	2 MW 	3 MW 				
Rated current I_n	Characteristic		Characteristic		Characteristic		Characteristic	
	B	C	B	C	B	C	B	C
0.3 A	–	5SL3114-7	–	5SL3514-7	–	5SL3214-7	–	–
0.5 A	–	5SL3105-7	–	5SL3505-7	–	5SL3205-7	–	–
1 A	–	5SL3101-7	–	5SL3501-7	–	5SL3201-7	–	5SL3301-7
1.6 A	–	5SL3115-7	–	5SL3515-7	–	5SL3215-7	–	–
2 A	–	5SL3102-7	–	5SL3502-7	–	5SL3202-7	–	5SL3302-7
3 A	–	5SL3103-7	–	5SL3503-7	–	5SL3203-7	–	5SL3303-7
4 A	–	5SL3104-7	–	5SL3504-7	–	5SL3204-7	–	5SL3304-7
6 A	5SL3106-6	5SL3106-7	5SL3506-6	5SL3506-7	5SL3206-6	5SL3206-7	5SL3306-6	5SL3306-7
8 A	–	5SL3108-7	–	5SL3508-7	–	5SL3208-7	–	–
10 A	5SL3110-6	5SL3110-7	5SL3510-6	5SL3510-7	5SL3210-6	5SL3210-7	5SL3310-6	5SL3310-7
13 A	5SL3113-6	5SL3113-7	5SL3513-6	5SL3513-7	5SL3213-6	5SL3213-7	–	–
16 A	5SL3116-6	5SL3116-7	5SL3516-6	5SL3516-7	5SL3216-6	5SL3216-7	5SL3316-6	5SL3316-7
20 A	5SL3120-6	5SL3120-7	5SL3520-6	5SL3520-7	5SL3220-6	5SL3220-7	5SL3320-6	5SL3320-7
25 A	5SL3125-6	5SL3125-7	5SL3525-6	5SL3525-7	5SL3225-6	5SL3225-7	5SL3325-6	5SL3325-7
32 A	5SL3132-6	5SL3132-7	5SL3532-6	5SL3532-7	5SL3232-6	5SL3232-7	5SL3332-6	5SL3332-7
40 A	5SL3140-6	5SL3140-7	5SL3540-6	5SL3540-7	5SL3240-6	5SL3240-7	5SL3340-6	5SL3340-7
50 A	5SL3150-6	5SL3150-7	5SL3550-6	5SL3550-7	5SL3250-6	5SL3250-7	5SL3350-6	5SL3350-7
63 A	5SL3163-6	5SL3163-7	5SL3563-6	5SL3563-7	5SL3263-6	5SL3263-7	5SL3363-6	5SL3363-7

Mounting concept

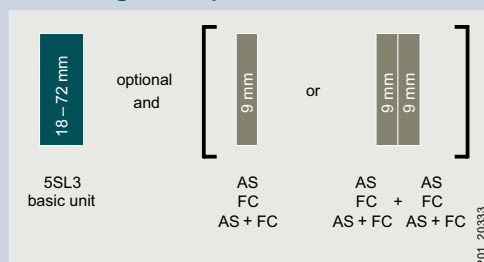

AS Auxiliary switches
 FC Fault signal contacts
 AS+FC Auxiliary switches and fault signal contacts

See page 3/48
 See page 3/50
 See page 3/53



3P+N		4P	
400 V AC		400 V AC	
4 MW		4 MW	
Characteristic		Characteristic	
B	C	B	C
–	–	–	–
–	–	–	–
–	5SL3601-7	–	5SL3401-7
–	–	–	–
–	5SL3602-7	–	5SL3402-7
–	5SL3603-7	–	5SL3403-7
–	5SL3604-7	–	5SL3404-7
5SL3606-6	5SL3606-7	–	5SL3406-7
–	5SL3608-7	–	–
5SL3610-6	5SL3610-7	–	5SL3410-7
5SL3613-6	5SL3613-7	–	5SL3413-7
5SL3616-6	5SL3616-7	–	5SL3416-7
5SL3620-6	5SL3620-7	–	5SL3420-7
5SL3625-6	5SL3625-7	–	5SL3425-7
5SL3632-6	5SL3632-7	–	5SL3432-7
5SL3640-6	5SL3640-7	–	5SL3440-7
5SL3650-6	5SL3650-7	–	5SL3450-7
5SL3663-6	5SL3663-7	–	5SL3463-7

3



Accessories

Auxiliary switches (AS)		Article No.
1 NO + 1 NC	Standard	5ST3010
	For low power	5ST3013
	For low power (with diode)	5ST3013-0XX01
2 NO	Standard	5ST3011
	For low power	5ST3014
2 NC	Standard	5ST3012
	For low power	5ST3015
1 CO	Standard	5ST3016

Fault signal contacts (FC)		Article No.
1 NO + 1 NC		5ST3020
2 NO		5ST3021
2 NC		5ST3022
Auxiliary switches and fault signal contacts (AS+FC)		Article No.
1 CO (AS) + 1 CO (FC)		5ST3062
5ST3 COM (AS+FC)		5ST3062-0MC

5SL6 miniature circuit breakers

6 kA

	1P	1P+N	2P			
Rated voltage U_n	230/400 V AC	230 V AC	400 V AC			
Mounting width	1 MW 	2 MW 	2 MW 			
Rated current I_n	Characteristic		Characteristic		Characteristic	
	B	C	B	C	B	C
0.3 A	–	5SL6114-7	–	5SL6514-7	–	5SL6214-7
0.5 A	–	5SL6105-7	–	5SL6505-7	–	5SL6205-7
1 A	–	5SL6101-7	–	5SL6501-7	–	5SL6201-7
1.6 A	–	5SL6115-7	–	5SL6515-7	–	5SL6215-7
2 A	5SL6102-6	5SL6102-7	–	5SL6502-7	–	5SL6202-7
3 A	–	5SL6103-7	–	5SL6503-7	–	5SL6203-7
4 A	5SL6104-6	5SL6104-7	–	5SL6504-7	–	5SL6204-7
6 A	5SL6106-6	5SL6106-7	5SL6506-6	5SL6506-7	5SL6206-6	5SL6206-7
8 A	–	5SL6108-7	–	5SL6508-7	–	5SL6208-7
10 A	5SL6110-6	5SL6110-7	5SL6510-6	5SL6510-7	5SL6210-6	5SL6210-7
13 A	5SL6113-6	5SL6113-7	5SL6513-6	5SL6513-7	5SL6213-6	5SL6213-7
16 A	5SL6116-6	5SL6116-7	5SL6516-6	5SL6516-7	5SL6216-6	5SL6216-7
20 A	5SL6120-6	5SL6120-7	5SL6520-6	5SL6520-7	5SL6220-6	5SL6220-7
25 A	5SL6125-6	5SL6125-7	5SL6525-6	5SL6525-7	5SL6225-6	5SL6225-7
32 A	5SL6132-6	5SL6132-7	5SL6532-6	5SL6532-7	5SL6232-6	5SL6232-7
40 A	5SL6140-6	5SL6140-7	5SL6540-6	5SL6540-7	5SL6240-6	5SL6240-7
50 A	5SL6150-6	5SL6150-7	5SL6550-6	5SL6550-7	5SL6250-6	5SL6250-7
63 A	5SL6163-6	5SL6163-7	5SL6563-6	5SL6563-7	5SL6263-6	5SL6263-7

Mounting concept

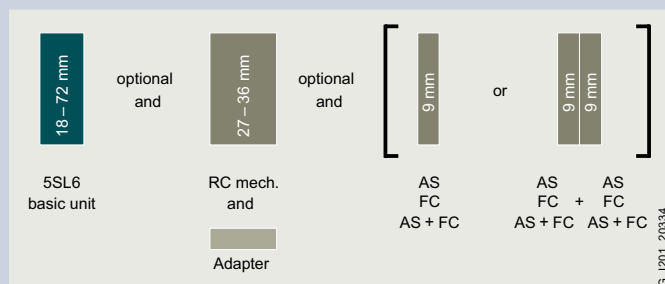

AS Auxiliary switches
 FC Fault signal contacts
 AS+FC Auxiliary switches and fault signal contacts
 RC mech. Remote control mechanisms

[See page 3/50](#)
[See page 3/52](#)
[See page 3/53](#)
[See page 3/58](#)



3P		3P+N		4P	
400 V AC		400 V AC		400 V AC	
3 MW		4 MW		4 MW	
Characteristic		Characteristic		Characteristic	
B	C	B	C	B	C
–	5SL6314-7	–	5SL6614-7	–	5SL6414-7
–	5SL6305-7	–	5SL6605-7	–	5SL6405-7
–	5SL6301-7	–	5SL6601-7	–	5SL6401-7
–	5SL6315-7	–	5SL6615-7	–	5SL6415-7
–	5SL6302-7	–	5SL6602-7	–	5SL6402-7
–	5SL6303-7	–	5SL6603-7	–	5SL6403-7
–	5SL6304-7	–	5SL6604-7	–	5SL6404-7
5SL6306-6	5SL6306-7	5SL6606-6	5SL6606-7	5SL6406-6	5SL6406-7
–	5SL6308-7	–	5SL6608-7	–	5SL6408-7
5SL6310-6	5SL6310-7	5SL6610-6	5SL6610-7	5SL6410-6	5SL6410-7
5SL6313-6	5SL6313-7	5SL6613-6	5SL6613-7	5SL6413-6	5SL6413-7
5SL6316-6	5SL6316-7	5SL6616-6	5SL6616-7	5SL6416-6	5SL6416-7
5SL6320-6	5SL6320-7	5SL6620-6	5SL6620-7	5SL6420-6	5SL6420-7
5SL6325-6	5SL6325-7	5SL6625-6	5SL6625-7	5SL6425-6	5SL6425-7
5SL6332-6	5SL6332-7	5SL6632-6	5SL6632-7	5SL6432-6	5SL6432-7
5SL6340-6	5SL6340-7	5SL6640-6	5SL6640-7	5SL6440-6	5SL6440-7
5SL6350-6	5SL6350-7	5SL6650-6	5SL6650-7	5SL6450-6	5SL6450-7
5SL6363-6	5SL6363-7	5SL6663-6	5SL6663-7	5SL6463-6	5SL6463-7

Accessories

Auxiliary switches (AS)		Article No.	Remote control mechanisms (RC mech.)		Article No.
1 NO + 1 NC	Standard	5ST3010	Basic	12 ... 30 V AC, 12 ... 48 V DC	5ST3053
	For low power	5ST3013		177 ... 270 V AC	5ST3054
	For low power (with diode)	5ST3013-0XX01	Power	12 ... 30 V AC, 12 ... 48 V DC	5ST3055
2 NO	Standard	5ST3011		177 ... 270 V AC	5ST3056
	For low power	5ST3014	Power with ARD	12 ... 30 V AC, 12 ... 48 V DC	5ST3057
2 NC	Standard	5ST3012		177 ... 270 V AC	5ST3058
	For low power	5ST3015	Power with extended function	12 ... 30 V AC, 12 ... 48 V DC	5ST3070
1 CO	Standard	5ST3016		170 ... 277 V AC, 77 ... 286 V DC	5ST3071
Fault signal contacts (FC)		Article No.	Adapters for remote control mechanisms (RC mech.)		Article No.
1 NO + 1 NC	Standard	5ST3020	1 ... 2 MW	5ST3820-6	
		5ST3021		5ST3820-7	
		5ST3022			
2 NO	Standard	5ST3020			
		5ST3021			
2 NC	Standard	5ST3022			
Auxiliary switches and fault signal contacts (AS+FC)		Article No.			
1 CO (AS) + 1 CO (FC)		5ST3062			
5ST3 COM (AS+FC)		5ST3062-OMC			

5SL4 miniature circuit breakers

10 kA

	1P	1P+N	2P
Rated voltage U_n	230/400 V AC	230 V AC	400 V AC
Mounting width	1 MW	2 MW	2 MW

Rated current I_n	Characteristic			Characteristic			Characteristic		
	B	C	D	B	C	D	B	C	D
0.3 A	–	5SL4114-7	5SL4114-8	–	5SL4514-7	5SL4514-8	–	5SL4214-7	5SL4214-8
0.5 A	–	5SL4105-7	5SL4105-8	–	5SL4505-7	5SL4505-8	–	5SL4205-7	5SL4205-8
1 A	5SL4101-6	5SL4101-7	5SL4101-8	5SL4501-6	5SL4501-7	5SL4501-8	5SL4201-6	5SL4201-7	5SL4201-8
1.6 A	–	5SL4115-7	5SL4115-8	–	5SL4515-7	5SL4515-8	–	5SL4215-7	5SL4215-8
2 A	5SL4102-6	5SL4102-7	5SL4102-8	5SL4502-6	5SL4502-7	5SL4502-8	5SL4202-6	5SL4202-7	5SL4202-8
3 A	5SL4103-6	5SL4103-7	5SL4103-8	5SL4503-6	5SL4503-7	5SL4503-8	5SL4203-6	5SL4203-7	5SL4203-8
4 A	5SL4104-6	5SL4104-7	5SL4104-8	5SL4504-6	5SL4504-7	5SL4504-8	5SL4204-6	5SL4204-7	5SL4204-8
6 A	5SL4106-6	5SL4106-7	5SL4106-8	5SL4506-6	5SL4506-7	5SL4506-8	5SL4206-6	5SL4206-7	5SL4206-8
8 A	5SL4108-6	5SL4108-7	5SL4108-8	5SL4508-6	5SL4508-7	5SL4508-8	5SL4208-6	5SL4208-7	5SL4208-8
10 A	5SL4110-6	5SL4110-7	5SL4110-8	5SL4510-6	5SL4510-7	5SL4510-8	5SL4210-6	5SL4210-7	5SL4210-8
13 A	5SL4113-6	5SL4113-7	5SL4113-8	5SL4513-6	5SL4513-7	5SL4513-8	5SL4213-6	5SL4213-7	5SL4213-8
16 A	5SL4116-6	5SL4116-7	5SL4116-8	5SL4516-6	5SL4516-7	5SL4516-8	5SL4216-6	5SL4216-7	5SL4216-8
20 A	5SL4120-6	5SL4120-7	5SL4120-8	5SL4520-6	5SL4520-7	5SL4520-8	5SL4220-6	5SL4220-7	5SL4220-8
25 A	5SL4125-6	5SL4125-7	5SL4125-8	5SL4525-6	5SL4525-7	5SL4525-8	5SL4225-6	5SL4225-7	5SL4225-8
32 A	5SL4132-6	5SL4132-7	5SL4132-8	5SL4532-6	5SL4532-7	5SL4532-8	5SL4232-6	5SL4232-7	5SL4232-8
40 A	5SL4140-6	5SL4140-7	5SL4140-8	5SL4540-6	5SL4540-7	5SL4540-8	5SL4240-6	5SL4240-7	5SL4240-8
50 A	5SL4150-6	5SL4150-7	5SL4150-8	5SL4550-6	5SL4550-7	5SL4550-8	5SL4250-6	5SL4250-7	5SL4250-8
63 A	5SL4163-6	5SL4163-7	5SL4163-8	5SL4563-6	5SL4563-7	5SL4563-8	5SL4263-6	5SL4263-7	5SL4263-8

Mounting concept

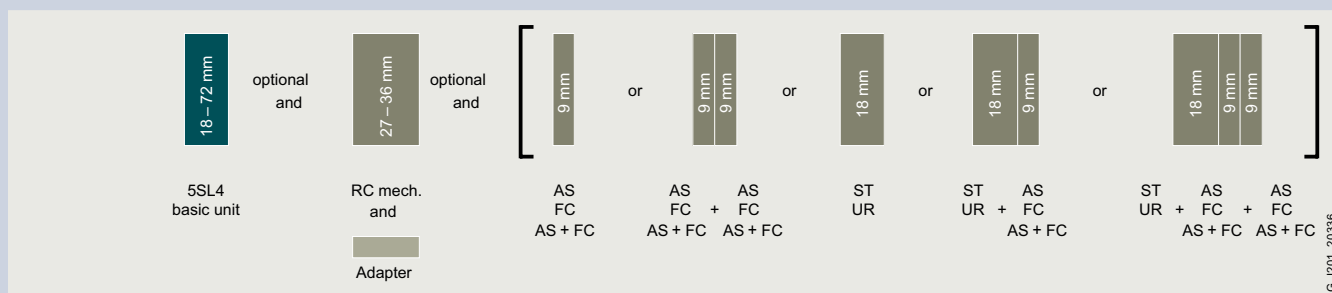
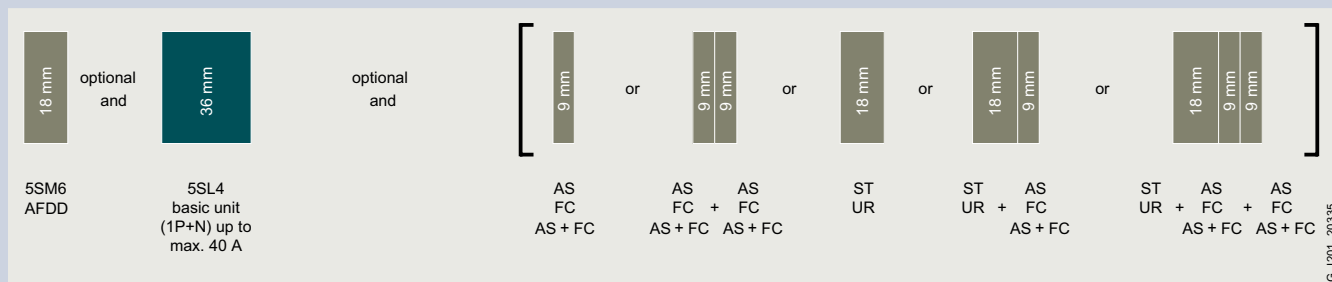

AFDD Arc fault detection units [See page 3/59](#) AS+FC Auxiliary switches and fault signal contacts [See page 3/53](#) UR Undervoltage releases [See page 3/57](#)
AS Auxiliary switches [See page 3/50](#) ST Shunt trips [See page 3/56](#) RC mech. Remote control mechanisms [See page 3/58](#)
FC Fault signal contacts [See page 3/52](#)



3P			3P+N			4P		
400 V AC			400 V AC			400 V AC		
3 MW			4 MW			4 MW		
Characteristic			Characteristic			Characteristic		
B	C	D	B	C	D	B	C	D
–	5SL4314-7	5SL4314-8	–	5SL4614-7	5SL4614-8	–	5SL4414-7	5SL4414-8
–	5SL4305-7	5SL4305-8	–	5SL4605-7	5SL4605-8	–	5SL4405-7	5SL4405-8
5SL4301-6	5SL4301-7	5SL4301-8	5SL4601-6	5SL4601-7	5SL4601-8	5SL4401-6	5SL4401-7	5SL4401-8
–	5SL4315-7	5SL4315-8	–	5SL4615-7	5SL4615-8	–	5SL4415-7	5SL4415-8
5SL4302-6	5SL4302-7	5SL4302-8	5SL4602-6	5SL4602-7	5SL4602-8	5SL4402-6	5SL4402-7	5SL4402-8
5SL4303-6	5SL4303-7	5SL4303-8	5SL4603-6	5SL4603-7	5SL4603-8	5SL4403-6	5SL4403-7	5SL4403-8
5SL4304-6	5SL4304-7	5SL4304-8	5SL4604-6	5SL4604-7	5SL4604-8	5SL4404-6	5SL4404-7	5SL4404-8
5SL4306-6	5SL4306-7	5SL4306-8	5SL4606-6	5SL4606-7	5SL4606-8	5SL4406-6	5SL4406-7	5SL4406-8
5SL4308-6	5SL4308-7	5SL4308-8	5SL4608-6	5SL4608-7	5SL4608-8	5SL4408-6	5SL4408-7	5SL4408-8
5SL4310-6	5SL4310-7	5SL4310-8	5SL4610-6	5SL4610-7	5SL4610-8	5SL4410-6	5SL4410-7	5SL4410-8
5SL4313-6	5SL4313-7	5SL4313-8	5SL4613-6	5SL4613-7	5SL4613-8	5SL4413-6	5SL4413-7	5SL4413-8
5SL4316-6	5SL4316-7	5SL4316-8	5SL4616-6	5SL4616-7	5SL4616-8	5SL4416-6	5SL4416-7	5SL4416-8
5SL4320-6	5SL4320-7	5SL4320-8	5SL4620-6	5SL4620-7	5SL4620-8	5SL4420-6	5SL4420-7	5SL4420-8
5SL4325-6	5SL4325-7	5SL4325-8	5SL4625-6	5SL4625-7	5SL4625-8	5SL4425-6	5SL4425-7	5SL4425-8
5SL4332-6	5SL4332-7	5SL4332-8	5SL4632-6	5SL4632-7	5SL4632-8	5SL4432-6	5SL4432-7	5SL4432-8
5SL4340-6	5SL4340-7	5SL4340-8	5SL4640-6	5SL4640-7	5SL4640-8	5SL4440-6	5SL4440-7	5SL4440-8
5SL4350-6	5SL4350-7	5SL4350-8	5SL4650-6	5SL4650-7	5SL4650-8	5SL4450-6	5SL4450-7	5SL4450-8
5SL4363-6	5SL4363-7	5SL4363-8	5SL4663-6	5SL4663-7	5SL4663-8	5SL4463-6	5SL4463-7	5SL4463-8



Accessories

Auxiliary switches (AS)		Article No.	Undervoltage releases (UR)		Article No.
1 NO + 1 NC	Standard	5ST3010	With integrated auxiliary switch	230 V AC	5ST3040
	For low power	5ST3013		110 V DC	5ST3041
	For low power (with diode)	5ST3013-0XX01		24 V DC	5ST3042
2 NO	Standard	5ST3011	Without integrated auxiliary switch	230 V AC	5ST3043
	For low power	5ST3014		110 V DC	5ST3044
2 NC	Standard	5ST3012		24 V DC	5ST3045
	For low power	5ST3015			
1 CO	Standard	5ST3016	Remote control mechanisms (RC mech.)		Article No.
Fault signal contacts (FC)		Article No.	Basic	12 ... 30 V AC, 12 ... 48 V DC	5ST3053
1 NO + 1 NC		5ST3020		177 ... 270 V AC	5ST3054
2 NO		5ST3021	Power	12 ... 30 V AC, 12 ... 48 V DC	5ST3055
2 NC		5ST3022		177 ... 270 V AC	5ST3056
Auxiliary switches and fault signal contacts (AS+FC)		Article No.	Power with ARD	12 ... 30 V AC, 12 ... 48 V DC	5ST3057
1 CO (AS) + 1 CO (FC)		5ST3062		177 ... 270 V AC	5ST3058
5ST3 COM (AS+FC)		5ST3062-0MC	Power with extended function	12 ... 30 V AC, 12 ... 48 V DC	5ST3070
Shunt trips (ST)		Article No.		170 ... 277 V AC, 77 ... 286 V DC	5ST3071
110 ... 415 V AC, 110 ... 220 V DC		5ST3030	Adapters for remote control mechanisms (RC mech.)		Article No.
24 ... 48 V AC/DC		5ST3031	1 ... 2 MW		5ST3820-6
12 V DC		5ST3031-0XX01	3 ... 4 MW		5ST3820-7
			Arc fault detection units (AFDD)		Article No.
			For basic units 1P+N (2 MW), not in combination with RC mech.	I_n up to 16 A	5SM6021-2
				I_n up to 40 A	5SM6024-2

5SJ6...-KS miniature circuit breakers

6 kA – plug-in terminal on outgoing side

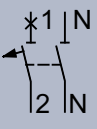

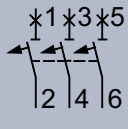
	1P	1P+N	2P	3P				
Rated voltage U_n	230/400 V AC	230/400 V AC	230/400 V AC	230/400 V AC				
Mounting width	1 MW 	2 MW 	2 MW 	3 MW 				
Rated current I_n	Characteristic		Characteristic		Characteristic		Characteristic	
	B	C	B	C	B	C	B	C
10 A	5SJ6110-6KS	5SJ6110-7KS	5SJ6510-6KS	5SJ6510-7KS	5SJ6210-6KS	5SJ6210-7KS	5SJ6310-6KS	5SJ6310-7KS
13 A	5SJ6113-6KS	5SJ6113-7KS	5SJ6513-6KS	5SJ6513-7KS	5SJ6213-6KS	5SJ6213-7KS	5SJ6313-6KS	5SJ6313-7KS
16 A	5SJ6116-6KS	5SJ6116-7KS	5SJ6516-6KS	5SJ6516-7KS	5SJ6216-6KS	5SJ6216-7KS	5SJ6316-6KS	5SJ6316-7KS
20 A	5SJ6120-6KS	5SJ6120-7KS	5SJ6520-6KS	5SJ6520-7KS	5SJ6220-6KS	5SJ6220-7KS	5SJ6320-6KS	5SJ6320-7KS

5SL30 miniature circuit breakers

1P+N 4.5 kA compact miniature circuit breakers

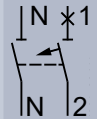
	1P+N (N pole right)	1P+N (N pole left)
Rated voltage U_n	230 V AC	230 V AC
Mounting width	2 MW	2 MW
		
Rated current I_n	Characteristic C	Characteristic C
2 A	5SL3002-7	5SL3002-7KL
4 A	5SL3004-7	5SL3004-7KL
6 A	5SL3006-7	5SL3006-7KL
8 A	5SL3008-7	5SL3008-7KL
10 A	5SL3010-7	5SL3010-7KL
13 A	5SL3013-7	5SL3013-7KL
16 A	5SL3016-7	5SL3016-7KL
20 A	5SL3020-7	5SL3020-7KL
25 A	5SL3025-7	5SL3025-7KL
32 A	5SL3032-7	5SL3032-7KL
40 A	5SL3040-7	5SL3040-7KL

Mounting concept

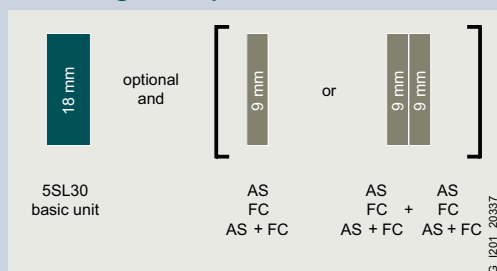

AS Auxiliary switches
 FC Fault signal contacts
 AS+FC Auxiliary switches and fault signal contacts

[See page 3/50](#)
[See page 3/52](#)
[See page 3/53](#)





Accessories

Auxiliary switches (AS)		Article No.
1 NO + 1 NC	Standard	5ST3010
	For low power	5ST3013
	For low power (with diode)	5ST3013-0XX01
2 NO	Standard	5ST3011
	For low power	5ST3014
2 NC	Standard	5ST3012
	For low power	5ST3015
1 CO	Standard	5ST3016

Fault signal contacts (FC)		Article No.
1 NO + 1 NC		5ST3020
2 NO		5ST3021
2 NC		5ST3022
Auxiliary switches and fault signal contacts (AS+FC)		Article No.
1 CO (AS) + 1 CO (FC)		5ST3062
5ST3 COM (AS+FC)		5ST3062-0MC

5SL60 miniature circuit breakers

1P+N 6 kA compact miniature circuit breakers

	1P+N (N pole right)	1P+N (N pole left)	
Rated voltage U_n	230 V AC	230 V AC	
Mounting width	1 MW 	1 MW 	
Rated current I_n	Characteristic		Characteristic
	B	C	C
2 A	–	5SL6002-7	5SL6002-7KL
4 A	–	5SL6004-7	5SL6004-7KL
6 A	5SL6006-6	5SL6006-7	5SL6006-7KL
8 A	–	5SL6008-7	5SL6008-7KL
10 A	5SL6010-6	5SL6010-7	5SL6010-7KL
13 A	5SL6013-6	5SL6013-7	5SL6013-7KL
16 A	5SL6016-6	5SL6016-7	5SL6016-7KL
20 A	5SL6020-6	5SL6020-7	5SL6020-7KL
25 A	5SL6025-6	5SL6025-7	5SL6025-7KL
32 A	5SL6032-6	5SL6032-7	5SL6032-7KL
40 A	5SL6040-6	5SL6040-7	5SL6040-7KL

Mounting concept

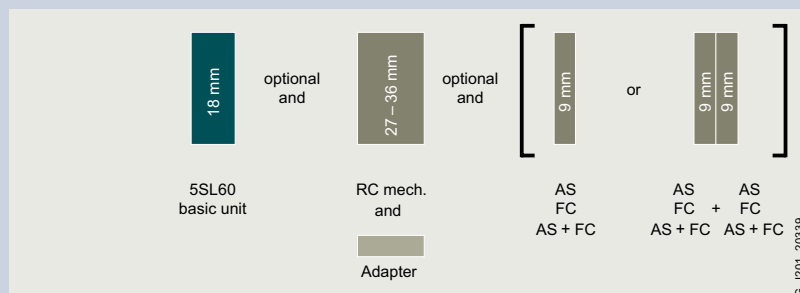
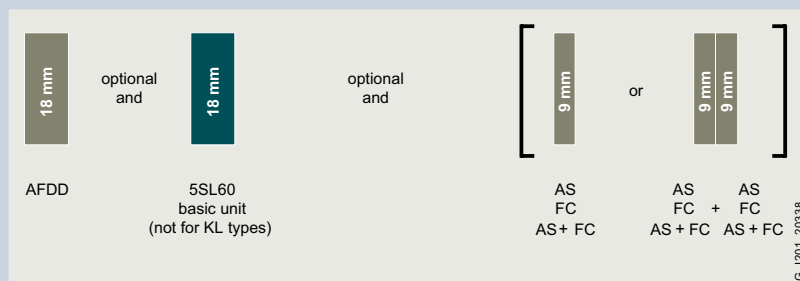

AFDD Arc fault detection units
 AS Auxiliary switches
 FC Fault signal contacts
 AS+FC Auxiliary switches and fault signal contacts
 RC mech. Remote control mechanisms

[See page 3/59](#)
[See page 3/50](#)
[See page 3/52](#)
[See page 3/53](#)
[See page 3/58](#)





Accessories

Auxiliary switches (AS)		Article No.
1 NO + 1 NC	Standard	5ST3010
	For low power	5ST3013
	For low power (with diode)	5ST3013-0XX01
2 NO	Standard	5ST3011
	For low power	5ST3014
2 NC	Standard	5ST3012
	For low power	5ST3015
1 CO	Standard	5ST3016
Fault signal contacts (FC)		Article No.
1 NO + 1 NC		5ST3020
2 NO		5ST3021
2 NC		5ST3022
Auxiliary switches and fault signal contacts (AS+FC)		Article No.
1 CO (AS) + 1 CO (FC)		5ST3062
5ST3 COM (AS+FC)		5ST3062-OMC

Remote control mechanisms (RC mech.)		Article No.
Basic	12 ... 30 V AC, 12 ... 48 V DC	5ST3053
	177 ... 270 V AC	5ST3054
Power	12 ... 30 V AC, 12 ... 48 V DC	5ST3055
	177 ... 270 V AC	5ST3056
Power with ARD	12 ... 30 V AC, 12 ... 48 V DC	5ST3057
	177 ... 270 V AC	5ST3058
Power with extended function	12 ... 30 V AC, 12 ... 48 V DC	5ST3070
	170 ... 277 V AC, 77 ... 286 V DC	5ST3071
Adapters for remote control mechanisms (RC mech.)		Article No.
1 MW		5ST3820-6
Arc fault detection units (AFDD)		Article No.
For basic units 1P + N (1 MW), not for KL types	I_n up to 16 A	5SM6011-2
	I_n up to 40 A	5SM6014-2

5SY6 miniature circuit breakers

6 kA

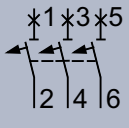
	1P	1P+N	2P	3P				
Rated voltage U_n	230/400 V AC	230 V AC	400 V AC	400 V AC				
Mounting width	1 MW 	2 MW 	2 MW 	3 MW 				
Rated current I_n	Characteristic		Characteristic		Characteristic		Characteristic	
	B	C	B	C	B	C	B	C
0.3 A	–	5SY6114-7	–	5SY6514-7	–	5SY6214-7	–	5SY6314-7
0.5 A	–	5SY6105-7	–	5SY6505-7	–	5SY6205-7	–	5SY6305-7
1 A	–	5SY6101-7	–	5SY6501-7	–	5SY6201-7	–	5SY6301-7
1.6 A	–	5SY6115-7	–	5SY6515-7	–	5SY6215-7	–	5SY6315-7
2 A	5SY6102-6	5SY6102-7	–	5SY6502-7	–	5SY6202-7	–	5SY6302-7
3 A	–	5SY6103-7	–	5SY6503-7	–	5SY6203-7	–	5SY6303-7
4 A	5SY6104-6	5SY6104-7	–	5SY6504-7	–	5SY6204-7	–	5SY6304-7
5 A	–	5SY6111-7	–	–	–	5SY6211-7	–	5SY6311-7
6 A	5SY6106-6	5SY6106-7	5SY6506-6	5SY6506-7	5SY6206-6	5SY6206-7	5SY6306-6	5SY6306-7
8 A	–	5SY6108-7	–	5SY6508-7	–	5SY6208-7	–	5SY6308-7
10 A	5SY6110-6	5SY6110-7	5SY6510-6	5SY6510-7	5SY6210-6	5SY6210-7	5SY6310-6	5SY6310-7
13 A	5SY6113-6	5SY6113-7	5SY6513-6	5SY6513-7	5SY6213-6	5SY6213-7	5SY6313-6	5SY6313-7
15 A	–	5SY6118-7	–	–	–	5SY6218-7	–	5SY6318-7
16 A	5SY6116-6	5SY6116-7	5SY6516-6	5SY6516-7	5SY6216-6	5SY6216-7	5SY6316-6	5SY6316-7
20 A	5SY6120-6	5SY6120-7	5SY6520-6	5SY6520-7	5SY6220-6	5SY6220-7	5SY6320-6	5SY6320-7
25 A	5SY6125-6	5SY6125-7	5SY6525-6	5SY6525-7	5SY6225-6	5SY6225-7	5SY6325-6	5SY6325-7
30 A	–	5SY6130-7	–	–	–	5SY6230-7	–	5SY6330-7
32 A	5SY6132-6	5SY6132-7	5SY6532-6	5SY6532-7	5SY6232-6	5SY6232-7	5SY6332-6	5SY6332-7
40 A	5SY6140-6	5SY6140-7	5SY6540-6	5SY6540-7	5SY6240-6	5SY6240-7	5SY6340-6	5SY6340-7
50 A	5SY6150-6	5SY6150-7	5SY6550-6	5SY6550-7	5SY6250-6	5SY6250-7	5SY6350-6	5SY6350-7
63 A	5SY6163-6	5SY6163-7	5SY6563-6	5SY6563-7	5SY6263-6	5SY6263-7	5SY6363-6	5SY6363-7

Mounting concept

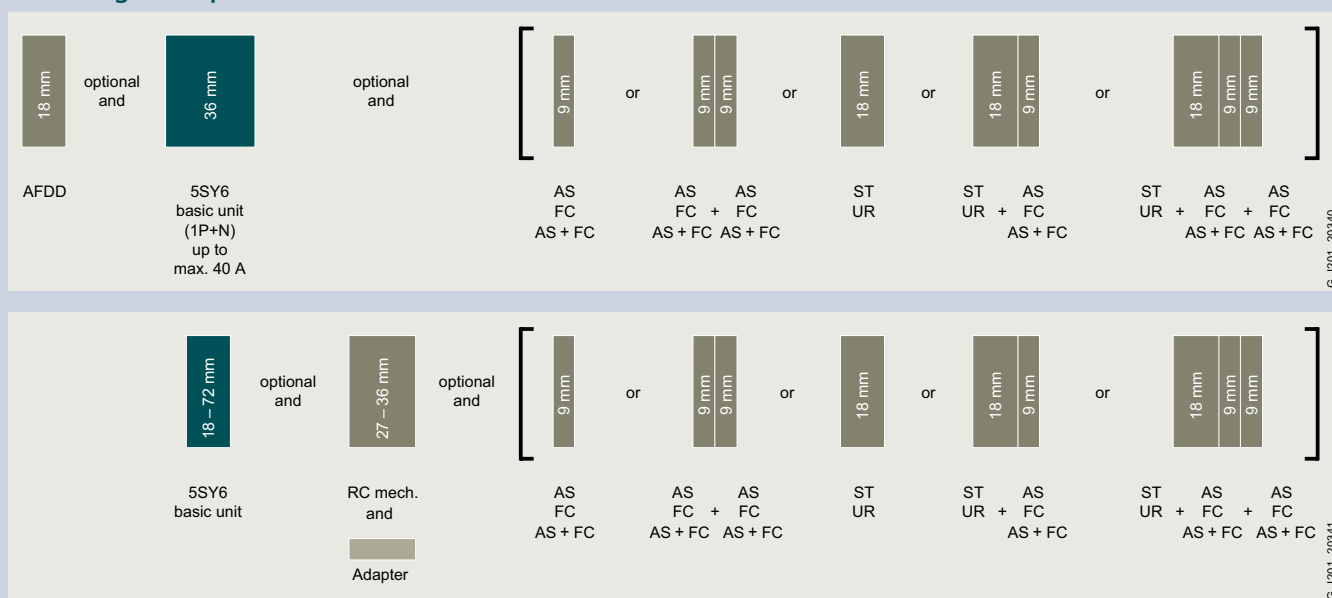

AFDD Arc fault detection units [See page 3/59](#) AS+FC Auxiliary switches and fault signal contacts [See page 3/53](#) UR Undervoltage releases [See page 3/57](#)
AS Auxiliary switches [See page 3/50](#) ST Shunt trips [See page 3/56](#) RC mech. Remote control mechanisms [See page 3/58](#)
FC Fault signal contacts [See page 3/52](#)



3P+N		4P	
400 V AC		400 V AC	
4 MW		4 MW	
Characteristic		Characteristic	
B	C	B	C
–	5SY6614-7	–	5SY6414-7
–	5SY6605-7	–	5SY6405-7
–	5SY6601-7	–	5SY6401-7
–	5SY6615-7	–	5SY6415-7
–	5SY6602-7	–	5SY6402-7
–	5SY6603-7	–	5SY6403-7
–	5SY6604-7	–	5SY6404-7
–	–	–	–
5SY6606-6	5SY6606-7	5SY6406-6	5SY6406-7
–	5SY6608-7	–	5SY6408-7
5SY6610-6	5SY6610-7	5SY6410-6	5SY6410-7
5SY6613-6	5SY6613-7	5SY6413-6	5SY6413-7
–	–	–	–
5SY6616-6	5SY6616-7	5SY6416-6	5SY6416-7
5SY6620-6	5SY6620-7	5SY6420-6	5SY6420-7
5SY6625-6	5SY6625-7	5SY6425-6	5SY6425-7
–	–	–	–
5SY6632-6	5SY6632-7	5SY6432-6	5SY6432-7
5SY6640-6	5SY6640-7	5SY6440-6	5SY6440-7
5SY6650-6	5SY6650-7	5SY6450-6	5SY6450-7
5SY6663-6	5SY6663-7	5SY6463-6	5SY6463-7

Accessories

Auxiliary switches (AS)		Article No.
1 NO + 1 NC	Standard	5ST3010
	For low power	5ST3013
	For low power (with diode)	5ST3013-0XX01
2 NO	Standard	5ST3011
	For low power	5ST3014
2 NC	Standard	5ST3012
	For low power	5ST3015
1 CO	Standard	5ST3016
Fault signal contacts (FC)		Article No.
1 NO + 1 NC		5ST3020
2 NO		5ST3021
2 NC		5ST3022
Auxiliary switches and fault signal contacts (AS+FC)		Article No.
1 CO (AS) + 1 CO (FC)		5ST3062
5ST3 COM (AS+FC)		5ST3062-0MC
Shunt trips (ST)		Article No.
110 ... 415 V AC, 110 ... 220 V DC		5ST3030
24 ... 48 V AC/DC		5ST3031
12 V DC		5ST3031-0XX01

Undervoltage releases (UR)		Article No.
With integrated auxiliary switch	230 V AC	5ST3040
	110 V DC	5ST3041
	24 V DC	5ST3042
Without integrated auxiliary switch	230 V AC	5ST3043
	110 V DC	5ST3044
	24 V DC	5ST3045
Remote control mechanisms (RC mech.)		Article No.
Basic	12 ... 30 V AC, 12 ... 48 V DC	5ST3053
	177 ... 270 V AC	5ST3054
	12 ... 30 V AC, 12 ... 48 V DC	5ST3055
Power	177 ... 270 V AC	5ST3056
	12 ... 30 V AC, 12 ... 48 V DC	5ST3057
Power with ARD	177 ... 270 V AC	5ST3058
	12 ... 30 V AC, 12 ... 48 V DC	5ST3070
Power with extended function	170 ... 277 V AC, 77 ... 286 V DC	5ST3071
Adapters for remote control mechanisms (RC mech.)		Article No.
1 ... 2 MW		5ST3820-1
3 ... 4 MW		5ST3820-2
Arc fault detection units (AFDD)		Article No.
For basic units 1P+N (2 MW), not in combination with RC mech.	I_n up to 16 A	5SM6021-2
	I_n up to 40 A	5SM6024-2

5SY4 miniature circuit breakers

10 kA

	1P	1P+N	2P									
Rated voltage U_n	230/400 V AC	230 V AC	400 V AC									
Mounting width	1 MW 	2 MW 	2 MW 									
Rated current I_n	Characteristic				Characteristic				Characteristic			
	A	B	C	D	A	B	C	D	A	B	C	D
0.3 A	–	–	5SY4114-7	5SY4114-8	–	–	5SY4514-7	5SY4514-8	–	–	5SY4214-7	5SY4214-8
0.5 A	5SY4105-5	–	5SY4105-7	5SY4105-8	–	–	5SY4505-7	5SY4505-8	5SY4205-5	–	5SY4205-7	5SY4205-8
1 A	5SY4101-5	5SY4101-6	5SY4101-7	5SY4101-8	5SY4501-5	–	5SY4501-7	5SY4501-8	5SY4201-5	5SY4201-6	5SY4201-7	5SY4201-8
1.6 A	5SY4115-5	5SY4115-6	5SY4115-7	5SY4115-8	5SY4515-5	5SY4515-6	5SY4515-7	5SY4515-8	5SY4215-5	5SY4215-6	5SY4215-7	5SY4215-8
2 A	5SY4102-5	5SY4102-6	5SY4102-7	5SY4102-8	5SY4502-5	–	5SY4502-7	5SY4502-8	5SY4202-5	5SY4202-6	5SY4202-7	5SY4202-8
3 A	5SY4103-5	5SY4103-6	5SY4103-7	5SY4103-8	5SY4503-5	–	5SY4503-7	5SY4503-8	5SY4203-5	5SY4203-6	5SY4203-7	5SY4203-8
4 A	5SY4104-5	5SY4104-6	5SY4104-7	5SY4104-8	5SY4504-5	5SY4504-6	5SY4504-7	5SY4504-8	5SY4204-5	5SY4204-6	5SY4204-7	5SY4204-8
5 A	–	–	5SY4111-7	–	–	–	–	–	–	–	5SY4211-7	–
6 A	5SY4106-5	5SY4106-6	5SY4106-7	5SY4106-8	5SY4506-5	5SY4506-6	5SY4506-7	5SY4506-8	5SY4206-5	5SY4206-6	5SY4206-7	5SY4206-8
8 A	5SY4108-5	5SY4108-6	5SY4108-7	5SY4108-8	5SY4508-5	–	5SY4508-7	5SY4508-8	5SY4208-5	5SY4208-6	5SY4208-7	5SY4208-8
10 A	5SY4110-5	5SY4110-6	5SY4110-7	5SY4110-8	5SY4510-5	5SY4510-6	5SY4510-7	5SY4510-8	5SY4210-5	5SY4210-6	5SY4210-7	5SY4210-8
13 A	5SY4113-5	5SY4113-6	5SY4113-7	5SY4113-8	5SY4513-5	5SY4513-6	5SY4513-7	5SY4513-8	5SY4213-5	5SY4213-6	5SY4213-7	5SY4213-8
15 A	–	–	5SY4118-7	–	–	–	–	–	–	–	5SY4218-7	–
16 A	5SY4116-5	5SY4116-6	5SY4116-7	5SY4116-8	5SY4516-5	5SY4516-6	5SY4516-7	5SY4516-8	5SY4216-5	5SY4216-6	5SY4216-7	5SY4216-8
20 A	5SY4120-5	5SY4120-6	5SY4120-7	5SY4120-8	5SY4520-5	5SY4520-6	5SY4520-7	5SY4520-8	5SY4220-5	5SY4220-6	5SY4220-7	5SY4220-8
25 A	5SY4125-5	5SY4125-6	5SY4125-7	5SY4125-8	5SY4525-5	5SY4525-6	5SY4525-7	5SY4525-8	5SY4225-5	5SY4225-6	5SY4225-7	5SY4225-8
30 A	–	–	5SY4130-7	–	–	–	–	–	–	–	5SY4230-7	–
32 A	5SY4132-5	5SY4132-6	5SY4132-7	5SY4132-8	5SY4532-5	5SY4532-6	5SY4532-7	5SY4532-8	5SY4232-5	5SY4232-6	5SY4232-7	5SY4232-8
35 A	–	–	5SY4135-7	–	–	–	–	–	–	–	5SY4235-7	–
40 A	5SY4140-5	5SY4140-6	5SY4140-7	5SY4140-8	5SY4540-5	5SY4540-6	5SY4540-7	5SY4540-8	5SY4240-5	5SY4240-6	5SY4240-7	5SY4240-8
45 A	–	–	5SY4145-7	–	–	–	–	–	–	–	5SY4245-7	–
50 A	5SY4150-5	5SY4150-6	5SY4150-7	5SY4150-8	5SY4550-5	5SY4550-6	5SY4550-7	5SY4550-8	5SY4250-5	5SY4250-6	5SY4250-7	5SY4250-8
60 A	–	–	5SY4160-7	–	–	–	–	–	–	–	5SY4260-7	–
63 A	5SY4163-5	5SY4163-6	5SY4163-7	5SY4163-8	5SY4563-5	5SY4563-6	5SY4563-7	5SY4563-8	5SY4263-5	5SY4263-6	5SY4263-7	5SY4263-8
80 A	–	5SY4180-6	5SY4180-7	–	–	–	5SY4580-7	–	–	5SY4280-6	5SY4280-7	–

Mounting concept

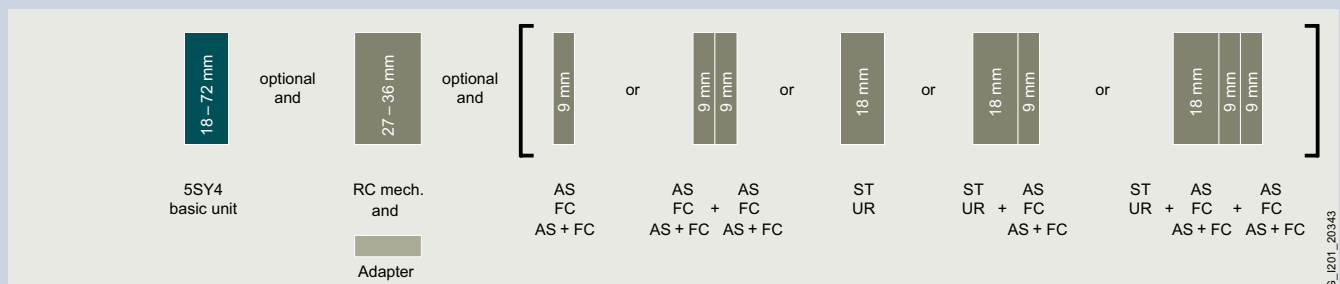
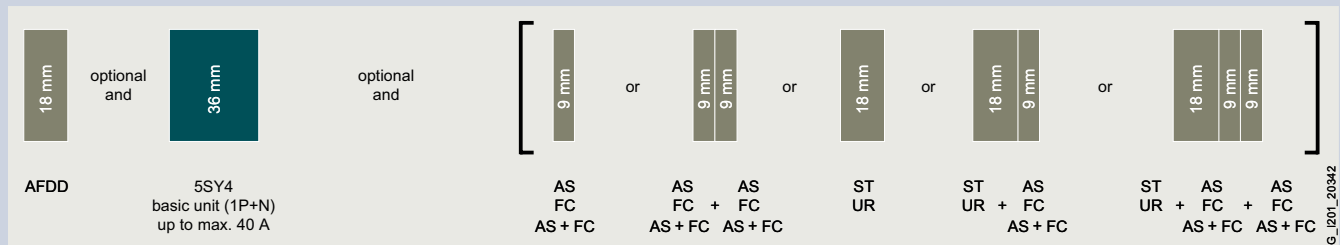



3P				3P+N				4P			
400 V AC				400 V AC				400 V AC			
3 MW				4 MW				4 MW			
Characteristic				Characteristic				Characteristic			
A	B	C	D	A	B	C	D	A	B	C	D
–	–	5SY4314-7	5SY4314-8	–	–	5SY4614-7	5SY4614-8	–	–	5SY4414-7	5SY4414-8
5SY4305-5	–	5SY4305-7	5SY4305-8	–	–	5SY4605-7	5SY4605-8	–	–	5SY4405-7	5SY4405-8
5SY4301-5	5SY4301-6	5SY4301-7	5SY4301-8	5SY4601-5	–	5SY4601-7	5SY4601-8	5SY4401-5	–	5SY4401-7	5SY4401-8
5SY4315-5	5SY4315-6	5SY4315-7	5SY4315-8	5SY4615-5	–	5SY4615-7	5SY4615-8	5SY4415-5	–	5SY4415-7	5SY4415-8
5SY4302-5	5SY4302-6	5SY4302-7	5SY4302-8	5SY4602-5	–	5SY4602-7	5SY4602-8	5SY4402-5	–	5SY4402-7	5SY4402-8
5SY4303-5	5SY4303-6	5SY4303-7	5SY4303-8	5SY4603-5	–	5SY4603-7	5SY4603-8	5SY4403-5	–	5SY4403-7	5SY4403-8
5SY4304-5	5SY4304-6	5SY4304-7	5SY4304-8	5SY4604-5	–	5SY4604-7	5SY4604-8	5SY4404-5	–	5SY4404-7	5SY4404-8
–	–	5SY4311-7	–	–	–	–	–	–	–	–	–
5SY4306-5	5SY4306-6	5SY4306-7	5SY4306-8	5SY4606-5	5SY4606-6	5SY4606-7	5SY4606-8	5SY4406-5	5SY4406-6	5SY4406-7	5SY4406-8
5SY4308-5	5SY4308-6	5SY4308-7	5SY4308-8	5SY4608-5	–	5SY4608-7	5SY4608-8	5SY4408-5	–	5SY4408-7	5SY4408-8
5SY4310-5	5SY4310-6	5SY4310-7	5SY4310-8	5SY4610-5	5SY4610-6	5SY4610-7	5SY4610-8	5SY4410-5	5SY4410-6	5SY4410-7	5SY4410-8
5SY4313-5	5SY4313-6	5SY4313-7	5SY4313-8	5SY4613-5	5SY4613-6	5SY4613-7	5SY4613-8	5SY4413-5	5SY4413-6	5SY4413-7	5SY4413-8
–	–	5SY4318-7	–	–	–	–	–	–	–	–	–
5SY4316-5	5SY4316-6	5SY4316-7	5SY4316-8	5SY4616-5	5SY4616-6	5SY4616-7	5SY4616-8	5SY4416-5	5SY4416-6	5SY4416-7	5SY4416-8
5SY4320-5	5SY4320-6	5SY4320-7	5SY4320-8	5SY4620-5	5SY4620-6	5SY4620-7	5SY4620-8	5SY4420-5	5SY4420-6	5SY4420-7	5SY4420-8
5SY4325-5	5SY4325-6	5SY4325-7	5SY4325-8	5SY4625-5	5SY4625-6	5SY4625-7	5SY4625-8	5SY4425-5	5SY4425-6	5SY4425-7	5SY4425-8
–	–	5SY4330-7	–	–	–	–	–	–	–	–	–
5SY4332-5	5SY4332-6	5SY4332-7	5SY4332-8	5SY4632-5	5SY4632-6	5SY4632-7	5SY4632-8	5SY4432-5	5SY4432-6	5SY4432-7	5SY4432-8
–	–	5SY4335-7	–	–	–	–	–	–	–	–	–
5SY4340-5	5SY4340-6	5SY4340-7	5SY4340-8	5SY4640-5	5SY4640-6	5SY4640-7	5SY4640-8	5SY4440-5	5SY4440-6	5SY4440-7	5SY4440-8
–	–	5SY4345-7	–	–	–	–	–	–	–	–	–
5SY4350-5	5SY4350-6	5SY4350-7	5SY4350-8	5SY4650-5	5SY4650-6	5SY4650-7	5SY4650-8	5SY4450-5	5SY4450-6	5SY4450-7	5SY4450-8
–	–	5SY4360-7	–	–	–	–	–	–	–	–	–
5SY4363-5	5SY4363-6	5SY4363-7	5SY4363-8	5SY4663-5	5SY4663-6	5SY4663-7	5SY4663-8	5SY4463-5	5SY4463-6	5SY4463-7	5SY4463-8
–	5SY4380-6	5SY4380-7	–	–	–	5SY4680-7	–	–	5SY4480-6	5SY4480-7	–

Accessories

Auxiliary switches (AS)		Article No.
1 NO + 1 NC	Standard	5ST3010
	For low power	5ST3013
	For low power (with diode)	5ST3013-0XX01
2 NO	Standard	5ST3011
	For low power	5ST3014
2 NC	Standard	5ST3012
	For low power	5ST3015
1 CO	Standard	5ST3016
Fault signal contacts (FC)		Article No.
1 NO + 1 NC		5ST3020
2 NO		5ST3021
2 NC		5ST3022
Auxiliary switches and fault signal contacts (AS+FC)		Article No.
1 CO (AS) + 1 CO (FC)		5ST3062
5ST3 COM (AS+FC)		5ST3062-0MC
Shunt trips (ST)		Article No.
110 ... 415 V AC, 110 ... 220 V DC		5ST3030
24 ... 48 V AC/DC		5ST3031
12 V DC		5ST3031-0XX01
Arc fault detection units (AFDD)		Article No.
For basic units 1P+N (2 MW)	I_n up to 16 A	5SM6021-2
	I_n up to 40 A	5SM6024-2
Undervoltage releases (UR)		Article No.
With integrated auxiliary switch	230 V AC	5ST3040
	110 V DC	5ST3041
	24 V DC	5ST3042
Without integrated auxiliary switch	230 V AC	5ST3043
	110 V DC	5ST3044
	24 V DC	5ST3045
Remote control mechanisms (RC mech.)		Article No.
Basic	12 ... 30 V AC, 12 ... 48 V DC	5ST3053
	177 ... 270 V AC	5ST3054
Power	12 ... 30 V AC, 12 ... 48 V DC	5ST3055
	177 ... 270 V AC	5ST3056
Power with ARD	12 ... 30 V AC, 12 ... 48 V DC	5ST3057
	177 ... 270 V AC	5ST3058
Power with extended function	12 ... 30 V AC, 12 ... 48 V DC	5ST3070
	170 ... 277 V AC, 77 ... 286 V DC	5ST3071
Adapters for remote control mechanisms (RC mech.)		Article No.
1 ... 2 MW		5ST3820-1
3 ... 4 MW		5ST3820-2

5SP4 miniature circuit breakers

10 kA

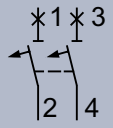
	1P	2P				
Rated voltage U_n	230/400 V AC	400 V AC				
Mounting width	1.5 MW 	3 MW 				
Rated current I_n	Characteristic			Characteristic		
	B	C	D	B	C	D
80 A	5SP4180-6	5SP4180-7	5SP4180-8	5SP4280-6	5SP4280-7	5SP4280-8
100 A	5SP4191-6	5SP4191-7	5SP4191-8	5SP4291-6	5SP4291-7	5SP4291-8
125 A	5SP4192-6	5SP4192-7	–	5SP4292-6	5SP4292-7	–

Mounting concept

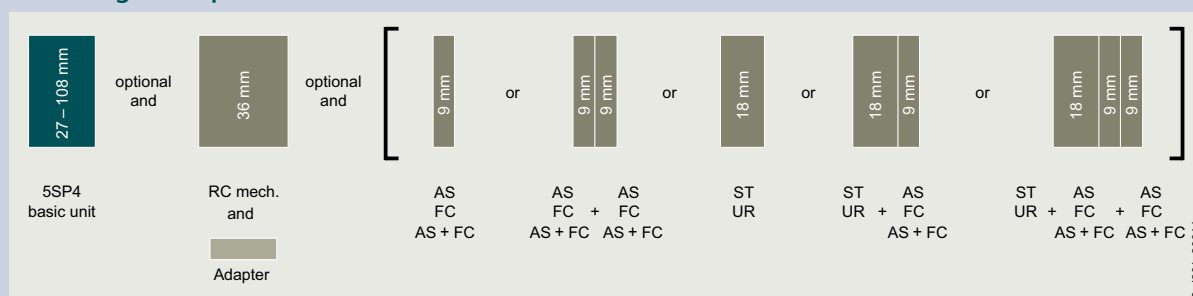

AS	Auxiliary switches	See page 3/50
FC	Fault signal contacts	See page 3/52
AS+FC	Auxiliary switches and fault signal contacts	See page 3/53
ST	Shunt trips	See page 3/56
UR	Undervoltage releases	See page 3/57
RC mech.	Remote control mechanisms	See page 3/58



3P			4P		
400 V AC			400 V AC		
4.5 MW			6 MW		
Characteristic			Characteristic		
B	C	D	B	C	D
5SP4380-6	5SP4380-7	5SP4380-8	5SP4480-6	5SP4480-7	5SP4480-8
5SP4391-6	5SP4391-7	5SP4391-8	5SP4491-6	5SP4491-7	5SP4491-8
5SP4392-6	5SP4392-7	–	5SP4492-6	5SP4492-7	–

3

Accessories

Auxiliary switches (AS)			Article No.		
1 NO + 1 NC	Standard	5ST3010	Undervoltage releases (UR)	230 V AC	5ST3040
	For low power	5ST3013		110 V DC	5ST3041
	For low power (with diode)	5ST3013-0XX01		24 V DC	5ST3042
2 NO	Standard	5ST3011	Without integrated auxiliary switch	230 V AC	5ST3043
	For low power	5ST3014		110 V DC	5ST3044
2 NC	Standard	5ST3012		24 V DC	5ST3045
	For low power	5ST3015	Remote control mechanisms (RC mech.) Article No.		
1 CO	Standard	5ST3016	Power	12 ... 30 V AC, 12 ... 48 V DC	5ST3055
Fault signal contacts (FC) Article No.				177 ... 270 V AC	5ST3056
1 NO + 1 NC		5ST3020	Power with extended function	12 ... 30 V AC, 12 ... 48 V DC	5ST3070
2 NO		5ST3021		170 ... 277 V AC, 77 ... 286 V DC	5ST3071
2 NC		5ST3022	Adapters for remote control mechanisms (RC mech.) Article No.		
Auxiliary switches and fault signal contacts (AS+FC) Article No.			1.5 MW		5ST3820-1
1 CO (AS) + 1 CO (FC)		5ST3062	3 ... 6 MW		5ST3820-2
5ST3 COM (AS+FC)		5ST3062-0MC			
Shunt trips (ST) Article No.					
110 ... 415 V AC, 110 ... 220 V DC		5ST3030			
24 ... 48 V AC/DC		5ST3031			
12 V DC		5ST3031-0XX01			

5SP5 miniature circuit breakers

10 kA

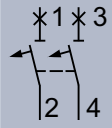
	1P	2P
Rated voltage U_n	220 V DC	440 V DC
Mounting width	1.5 MW 	3 MW 
Rated current I_n		
80 A	5SP5180-7CC	5SP5280-7CC
100 A	5SP5191-7CC	5SP5291-7CC
125 A	5SP5192-7CC	5SP5292-7CC

Mounting concept

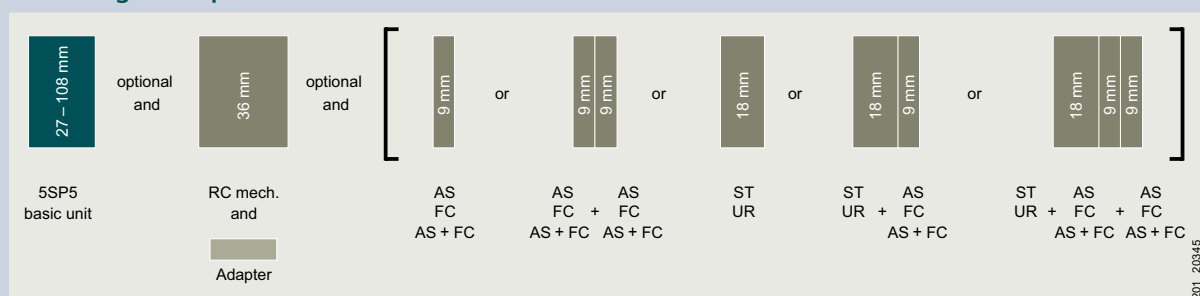

AS	Auxiliary switches
FC	Fault signal contacts
AS+FC	Auxiliary switches and fault signal contacts
ST	Shunt trips
UR	Undervoltage releases
RC mech.	Remote control mechanisms

[See page 3/50](#)

[See page 3/52](#)

[See page 3/53](#)

[See page 3/56](#)

[See page 3/57](#)

[See page 3/58](#)



Accessories

Auxiliary switches (AS)		Article No.
1 NO + 1 NC	Standard	5ST3010
	For low power	5ST3013
	For low power (with diode)	5ST3013-0XX01
2 NO	Standard	5ST3011
	For low power	5ST3014
2 NC	Standard	5ST3012
	For low power	5ST3015
1 CO	Standard	5ST3016
Fault signal contacts (FC)		Article No.
1 NO + 1 NC		5ST3020
2 NO		5ST3021
2 NC		5ST3022
Auxiliary switches and fault signal contacts (AS+FC)		Article No.
1 CO (AS) + 1 CO (FC)		5ST3062
5ST3 COM (AS+FC)		5ST3062-0MC
Shunt trips (ST)		Article No.
110 ... 415 V AC, 110 ... 220 V DC		5ST3030
24 ... 48 V AC/DC		5ST3031
12 V DC		5ST3031-0XX01

Undervoltage releases (UR)		Article No.
With integrated auxiliary switch	230 V AC	5ST3040
	110 V DC	5ST3041
	24 V DC	5ST3042
Without integrated auxiliary switch	230 V AC	5ST3043
	110 V DC	5ST3044
	24 V DC	5ST3045
Remote control mechanisms (RC mech.)		Article No.
Power	12 ... 30 V AC, 12 ... 48 V DC	5ST3055
	177 ... 270 V AC	5ST3056
Power with extended function	12 ... 30 V AC, 12 ... 48 V DC	5ST3070
	170 ... 277 V AC, 77 ... 286 V DC	5ST3071
Adapters for remote control mechanisms (RC mech.)		Article No.
1.5 MW		5ST3820-1
3 ... 6 MW		5ST3820-2

5SY5 miniature circuit breakers

10 kA

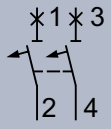
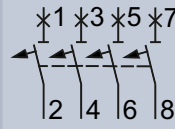
	1P	2P	4P			
Rated voltage U_n	230/400 V AC, 220 V DC	400 V AC, 440 V DC	400 V AC, 880 V DC			
Mounting width	1 MW 	2 MW 	4 MW 			
Rated current I_n	Characteristic		Characteristic		Characteristic	
	B	C	B	C	B	C
0.3 A	–	5SY5114-7	–	5SY5214-7	–	5SY5414-7
0.5 A	–	5SY5105-7	–	5SY5205-7	–	5SY5405-7
1 A	–	5SY5101-7	–	5SY5201-7	–	5SY5401-7
1.6 A	–	5SY5115-7	–	5SY5215-7	–	5SY5415-7
2 A	5SY5102-6	5SY5102-7	5SY5202-6	5SY5202-7	–	5SY5402-7
3 A	–	5SY5103-7	–	5SY5203-7	–	5SY5403-7
4 A	5SY5104-6	5SY5104-7	5SY5204-6	5SY5204-7	–	5SY5404-7
6 A	5SY5106-6	5SY5106-7	5SY5206-6	5SY5206-7	5SY5406-6	5SY5406-7
8 A	5SY5108-6	5SY5108-7	5SY5208-6	5SY5208-7	–	5SY5408-7
10 A	5SY5110-6	5SY5110-7	5SY5210-6	5SY5210-7	5SY5410-6	5SY5410-7
13 A	5SY5113-6	5SY5113-7	5SY5213-6	5SY5213-7	5SY5413-6	5SY5413-7
16 A	5SY5116-6	5SY5116-7	5SY5216-6	5SY5216-7	5SY5416-6	5SY5416-7
20 A	5SY5120-6	5SY5120-7	5SY5220-6	5SY5220-7	5SY5420-6	5SY5420-7
25 A	5SY5125-6	5SY5125-7	5SY5225-6	5SY5225-7	5SY5425-6	5SY5425-7
32 A	5SY5132-6	5SY5132-7	5SY5232-6	5SY5232-7	5SY5432-6	5SY5432-7
40 A	5SY5140-6	5SY5140-7	5SY5240-6	5SY5240-7	5SY5440-6	5SY5440-7
50 A	5SY5150-6	5SY5150-7	5SY5250-6	5SY5250-7	5SY5450-6	5SY5450-7
63 A	5SY5163-6	5SY5163-7	5SY5263-6	5SY5263-7	5SY5463-6	5SY5463-7

Mounting concept

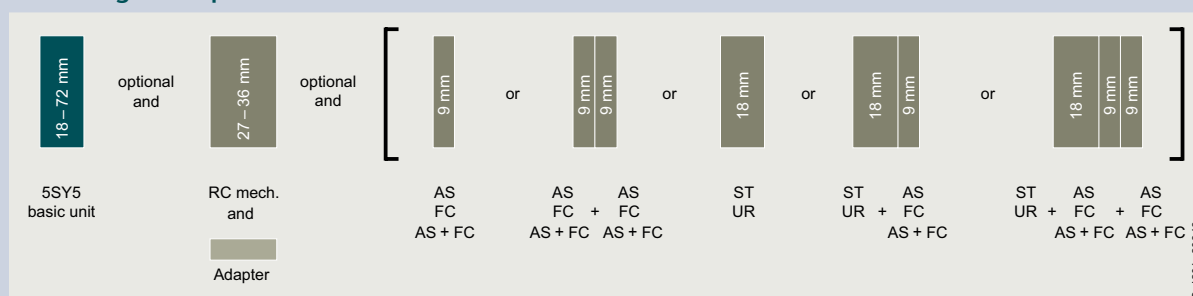

AS Auxiliary switches
 FC Fault signal contacts
 AS+FC Auxiliary switches and fault signal contacts
 ST Shunt trips
 UR Undervoltage releases
 RC mech. Remote control mechanisms

[See page 3/50](#)

[See page 3/52](#)

[See page 3/53](#)

[See page 3/56](#)

[See page 3/57](#)

[See page 3/58](#)





Accessories

Auxiliary switches (AS)		Article No.
1 NO + 1 NC	Standard	5ST3010
	For low power	5ST3013
	For low power (with diode)	5ST3013-0XX01
2 NO	Standard	5ST3011
	For low power	5ST3014
2 NC	Standard	5ST3012
	For low power	5ST3015
1 CO	Standard	5ST3016
Fault signal contacts (FC)		Article No.
1 NO + 1 NC		5ST3020
2 NO		5ST3021
2 NC		5ST3022
Auxiliary switches and fault signal contacts (AS+FC)		Article No.
1 CO (AS) + 1 CO (FC)		5ST3062
5ST3 COM (AS+FC)		5ST3062-0MC
Shunt trips (ST)		Article No.
110 ... 415 V AC, 110 ... 220 V DC		5ST3030
24 ... 48 V AC/DC		5ST3031
12 V DC		5ST3031-0XX01

Undervoltage releases (UR)		Article No.
With integrated auxiliary switch	230 V AC	5ST3040
	110 V DC	5ST3041
	24 V DC	5ST3042
Without integrated auxiliary switch	230 V AC	5ST3043
	110 V DC	5ST3044
	24 V DC	5ST3045
Remote control mechanisms (RC mech.)		Article No.
Basic	12 ... 30 V AC, 12 ... 48 V DC	5ST3053
	177 ... 270 V AC	5ST3054
Power	12 ... 30 V AC, 12 ... 48 V DC	5ST3055
	177 ... 270 V AC	5ST3056
Power with ARD	12 ... 30 V AC, 12 ... 48 V DC	5ST3057
	177 ... 270 V AC	5ST3058
Power with extended function	12 ... 30 V AC, 12 ... 48 V DC	5ST3070
	170 ... 277 V AC, 77 ... 286 V DC	5ST3071
Adapters for remote control mechanisms (RC mech.)		Article No.
1 ... 2 MW		5ST3820-1
4 MW		5ST3820-2

5SY7 miniature circuit breakers

15 kA

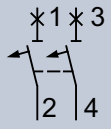
	1P	1P+N	2P
Rated voltage U_n	230/400 V AC	230 V AC	400 V AC
Mounting width	1 MW 	2 MW 	2 MW 

Rated current I_n	Main MCB, line side of meter	Characteristic			Characteristic			Characteristic		
		B	C	D	B	C	D	B	C	D
0.3 A	–	–	5SY7114-7	5SY7114-8	–	5SY7514-7	5SY7514-8	–	5SY7214-7	5SY7214-8
0.5 A	–	–	5SY7105-7	5SY7105-8	–	5SY7505-7	5SY7505-8	–	5SY7205-7	5SY7205-8
1 A	–	–	5SY7101-7	5SY7101-8	–	5SY7501-7	5SY7501-8	–	5SY7201-7	5SY7201-8
1.6 A	–	–	5SY7115-7	5SY7115-8	–	5SY7515-7	5SY7515-8	–	5SY7215-7	5SY7215-8
2 A	–	–	5SY7102-7	5SY7102-8	–	5SY7502-7	5SY7502-8	–	5SY7202-7	5SY7202-8
3 A	–	–	5SY7103-7	5SY7103-8	–	5SY7503-7	5SY7503-8	–	5SY7203-7	5SY7203-8
4 A	–	–	5SY7104-7	5SY7104-8	–	5SY7504-7	5SY7504-8	–	5SY7204-7	5SY7204-8
6 A	–	5SY7106-6	5SY7106-7	5SY7106-8	5SY7506-6	5SY7506-7	5SY7506-8	5SY7206-6	5SY7206-7	5SY7206-8
	■	5SY7106-6KK13	–	–	–	–	–	–	–	–
8 A	–	–	5SY7108-7	5SY7108-8	–	5SY7508-7	5SY7508-8	–	5SY7208-7	5SY7208-8
10 A	–	5SY7110-6	5SY7110-7	5SY7110-8	5SY7510-6	5SY7510-7	5SY7510-8	5SY7210-6	5SY7210-7	5SY7210-8
	■	5SY7110-6KK13	–	–	–	–	–	–	–	–
13 A	–	5SY7113-6	5SY7113-7	5SY7113-8	5SY7513-6	5SY7513-7	5SY7513-8	5SY7213-6	5SY7213-7	5SY7213-8
16 A	–	5SY7116-6	5SY7116-7	5SY7116-8	5SY7516-6	5SY7516-7	5SY7516-8	5SY7216-6	5SY7216-7	5SY7216-8
20 A	–	5SY7120-6	5SY7120-7	5SY7120-8	5SY7520-6	5SY7520-7	5SY7520-8	5SY7220-6	5SY7220-7	5SY7220-8
25 A	–	5SY7125-6	5SY7125-7	5SY7125-8	5SY7525-6	5SY7525-7	5SY7525-8	5SY7225-6	5SY7225-7	5SY7225-8
32 A	–	5SY7132-6	5SY7132-7	5SY7132-8	5SY7532-6	5SY7532-7	5SY7532-8	5SY7232-6	5SY7232-7	5SY7232-8
40 A	–	5SY7140-6	5SY7140-7	5SY7140-8	5SY7540-6	5SY7540-7	5SY7540-8	5SY7240-6	5SY7240-7	5SY7240-8
50 A	–	5SY7150-6	5SY7150-7	5SY7150-8	5SY7550-6	5SY7550-7	5SY7550-8	5SY7250-6	5SY7250-7	5SY7250-8
63 A	–	5SY7163-6	5SY7163-7	5SY7163-8	5SY7563-6	5SY7563-7	5SY7563-8	5SY7263-6	5SY7263-7	5SY7263-8

Mounting concept

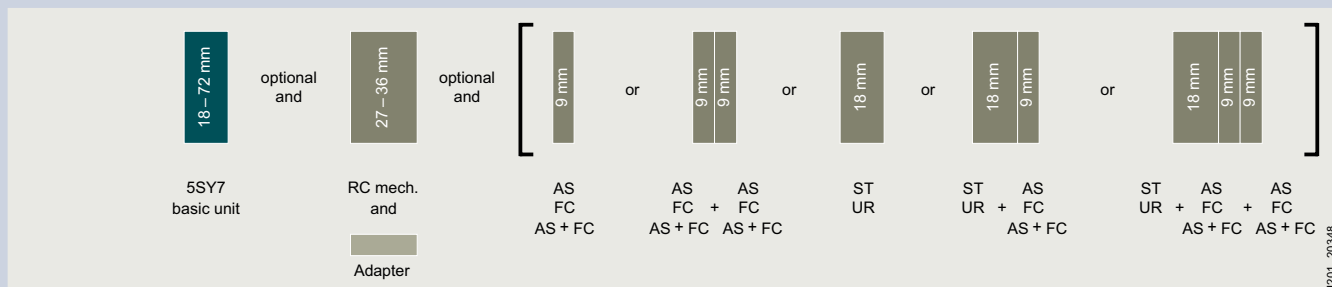
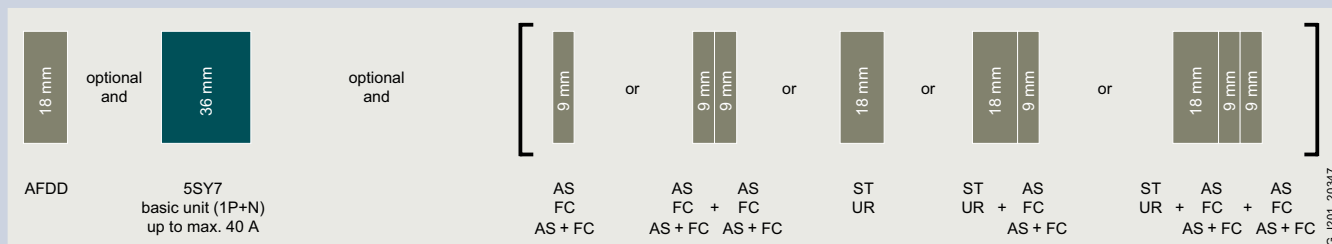

- AFDD Arc fault detection units [See page 3/59](#)
- AS Auxiliary switches [See page 3/50](#)
- FC Fault signal contacts [See page 3/52](#)
- AS+FC Auxiliary switches and fault signal contacts [See page 3/53](#)
- ST Shunt trips [See page 3/56](#)
- UR Undervoltage releases [See page 3/57](#)
- RC mech. Remote control mechanisms [See page 3/58](#)



3P			3P+N			4P		
400 V AC			400 V AC			400 V AC		
3 MW			4 MW			4 MW		
Characteristic			Characteristic			Characteristic		
B	C	D	B	C	D	B	C	D
–	5SY7314-7	5SY7314-8	–	5SY7614-7	5SY7614-8	–	5SY7414-7	5SY7414-8
–	5SY7305-7	5SY7305-8	–	5SY7605-7	5SY7605-8	–	5SY7405-7	5SY7405-8
–	5SY7301-7	5SY7301-8	–	5SY7601-7	5SY7601-8	–	5SY7401-7	5SY7401-8
–	5SY7315-7	5SY7315-8	–	5SY7615-7	5SY7615-8	–	5SY7415-7	5SY7415-8
–	5SY7302-7	5SY7302-8	–	5SY7602-7	5SY7602-8	–	5SY7402-7	5SY7402-8
–	5SY7303-7	5SY7303-8	–	5SY7603-7	5SY7603-8	–	5SY7403-7	5SY7403-8
–	5SY7304-7	5SY7304-8	–	5SY7604-7	5SY7604-8	–	5SY7404-7	5SY7404-8
5SY7306-6	5SY7306-7	5SY7306-8	5SY7606-6	5SY7606-7	5SY7606-8	5SY7406-6	5SY7406-7	5SY7406-8
–	–	–	–	–	–	–	–	–
–	5SY7308-7	5SY7308-8	–	5SY7608-7	5SY7608-8	–	5SY7408-7	5SY7408-8
5SY7310-6	5SY7310-7	5SY7310-8	5SY7610-6	5SY7610-7	5SY7610-8	5SY7410-6	5SY7410-7	5SY7410-8
–	–	–	–	–	–	–	–	–
5SY7313-6	5SY7313-7	5SY7313-8	5SY7613-6	5SY7613-7	5SY7613-8	5SY7413-6	5SY7413-7	5SY7413-8
5SY7316-6	5SY7316-7	5SY7316-8	5SY7616-6	5SY7616-7	5SY7616-8	5SY7416-6	5SY7416-7	5SY7416-8
5SY7320-6	5SY7320-7	5SY7320-8	5SY7620-6	5SY7620-7	5SY7620-8	5SY7420-6	5SY7420-7	5SY7420-8
5SY7325-6	5SY7325-7	5SY7325-8	5SY7625-6	5SY7625-7	5SY7625-8	5SY7425-6	5SY7425-7	5SY7425-8
5SY7332-6	5SY7332-7	5SY7332-8	5SY7632-6	5SY7632-7	5SY7632-8	5SY7432-6	5SY7432-7	5SY7432-8
5SY7340-6	5SY7340-7	5SY7340-8	5SY7640-6	5SY7640-7	5SY7640-8	5SY7440-6	5SY7440-7	5SY7440-8
5SY7350-6	5SY7350-7	5SY7350-8	5SY7650-6	5SY7650-7	5SY7650-8	5SY7450-6	5SY7450-7	5SY7450-8
5SY7363-6	5SY7363-7	5SY7363-8	5SY7663-6	5SY7663-7	5SY7663-8	5SY7463-6	5SY7463-7	5SY7463-8

Accessories

Auxiliary switches (AS)		Article No.	Undervoltage releases (UR)		Article No.
1 NO + 1 NC	Standard	5ST3010	With integrated auxiliary switch	230 V AC	5ST3040
	For low power	5ST3013		110 V DC	5ST3041
	For low power (with diode)	5ST3013-0XX01		24 V DC	5ST3042
2 NO	Standard	5ST3011	Without integrated auxiliary switch	230 V AC	5ST3043
	For low power	5ST3014		110 V DC	5ST3044
2 NC	Standard	5ST3012		24 V DC	5ST3045
	For low power	5ST3015			
1 CO	Standard	5ST3016	Remote control mechanisms (RC mech.)		Article No.
Fault signal contacts (FC)		Article No.	Basic	12 ... 30 V AC, 12 ... 48 V DC	5ST3053
1 NO + 1 NC		5ST3020		177 ... 270 V AC	5ST3054
2 NO		5ST3021	Power	12 ... 30 V AC, 12 ... 48 V DC	5ST3055
2 NC		5ST3022		177 ... 270 V AC	5ST3056
Auxiliary switches and fault signal contacts (AS+FC)		Article No.	Power with ARD	12 ... 30 V AC, 12 ... 48 V DC	5ST3057
1 CO (AS) + 1 CO (FC)		5ST3062		177 ... 270 V AC	5ST3058
5ST3 COM (AS+FC)		5ST3062-0MC	Power with extended function	12 ... 30 V AC, 12 ... 48 V DC	5ST3070
				170 ... 277 V AC, 77 ... 286 V DC	5ST3071
Shunt trips (ST)		Article No.	Adapters for remote control mechanisms (RC mech.)		Article No.
110 ... 415 V AC, 110 ... 220 V DC		5ST3030	1 ... 2 MW		5ST3820-1
24 ... 48 V AC/DC		5ST3031	3 ... 4 MW		5ST3820-2
12 V DC		5ST3031-0XX01	Arc fault detection units (AFDD)		Article No.
			For basic units 1P+N (2 MW)	I_n up to 16 A	5SM6021-2
				I_n up to 40 A	5SM6024-2

5SY8 miniature circuit breakers

25 kA

3

	1P	1P+N	2P	3P				
Rated voltage U_n	230/400 V AC	230 V AC	400 V AC	400 V AC				
Mounting width	1 MW 	2 MW 	2 MW 	3 MW 				
Rated current I_n	Characteristic		Characteristic		Characteristic		Characteristic	
	C	D	C	D	C	D	C	D
0.3 A	5SY8114-7	5SY8114-8	5SY8514-7	5SY8514-8	5SY8214-7	5SY8214-8	5SY8314-7	5SY8314-8
0.5 A	5SY8105-7	5SY8105-8	5SY8505-7	5SY8505-8	5SY8205-7	5SY8205-8	5SY8305-7	5SY8305-8
1 A	5SY8101-7	5SY8101-8	5SY8501-7	5SY8501-8	5SY8201-7	5SY8201-8	5SY8301-7	5SY8301-8
1.6 A	5SY8115-7	5SY8115-8	5SY8515-7	5SY8515-8	5SY8215-7	5SY8215-8	5SY8315-7	5SY8315-8
2 A	5SY8102-7	5SY8102-8	5SY8502-7	5SY8502-8	5SY8202-7	5SY8202-8	5SY8302-7	5SY8302-8
3 A	5SY8103-7	5SY8103-8	5SY8503-7	5SY8503-8	5SY8203-7	5SY8203-8	5SY8303-7	5SY8303-8
4 A	5SY8104-7	5SY8104-8	5SY8504-7	5SY8504-8	5SY8204-7	5SY8204-8	5SY8304-7	5SY8304-8
6 A	5SY8106-7	5SY8106-8	5SY8506-7	5SY8506-8	5SY8206-7	5SY8206-8	5SY8306-7	5SY8306-8
8 A	5SY8108-7	5SY8108-8	5SY8508-7	5SY8508-8	5SY8208-7	5SY8208-8	5SY8308-7	5SY8308-8
10 A	5SY8110-7	5SY8110-8	5SY8510-7	5SY8510-8	5SY8210-7	5SY8210-8	5SY8310-7	5SY8310-8
12.5 A	-	-	-	-	-	-	-	-
13 A	5SY8113-7	5SY8113-8	5SY8513-7	5SY8513-8	5SY8213-7	5SY8213-8	5SY8313-7	5SY8313-8
16 A	5SY8116-7	5SY8116-8	5SY8516-7	5SY8516-8	5SY8216-7	5SY8216-8	5SY8316-7	5SY8316-8
20 A	5SY8120-7	5SY8120-8	5SY8520-7	5SY8520-8	5SY8220-7	5SY8220-8	5SY8320-7	5SY8320-8
25 A	5SY8125-7	5SY8125-8	5SY8525-7	5SY8525-8	5SY8225-7	5SY8225-8	5SY8325-7	5SY8325-8
32 A	5SY8132-7	5SY8132-8	5SY8532-7	5SY8532-8	5SY8232-7	5SY8232-8	5SY8332-7	5SY8332-8
40 A	5SY8140-7	5SY8140-8	5SY8540-7	5SY8540-8	5SY8240-7	5SY8240-8	5SY8340-7	5SY8340-8
50 A	5SY8150-7	5SY8150-8	5SY8550-7	5SY8550-8	5SY8250-7	5SY8250-8	5SY8350-7	5SY8350-8
63 A	5SY8163-7	5SY8163-8	5SY8563-7	5SY8563-8	5SY8263-7	5SY8263-8	5SY8363-7	5SY8363-8

Mounting concept

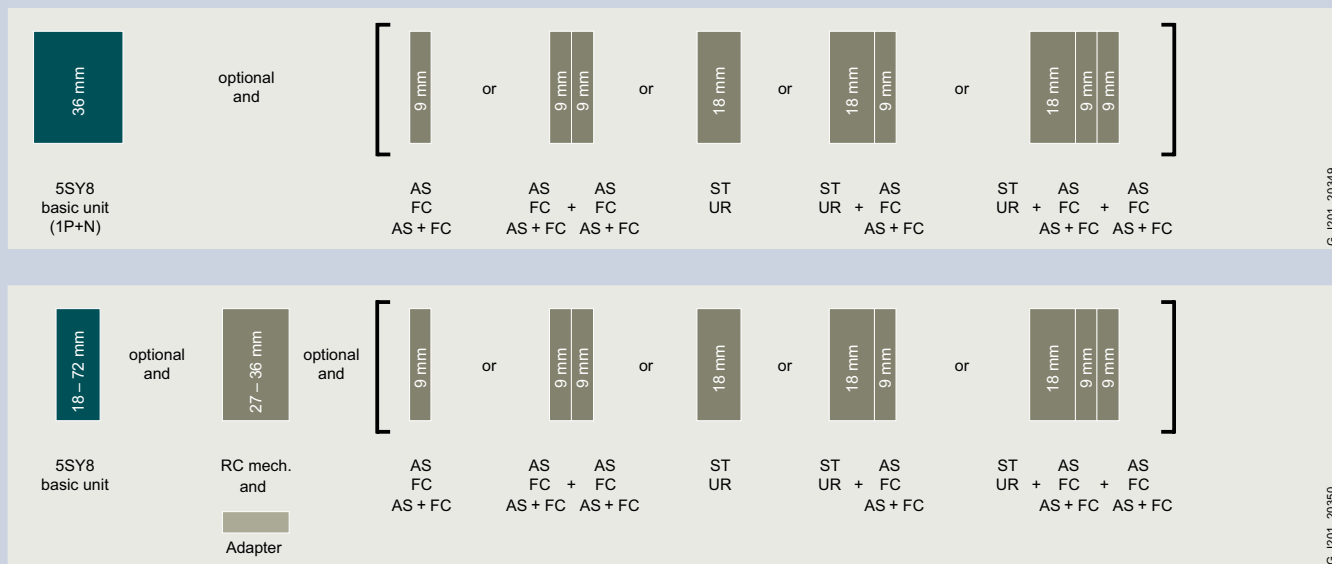

- AFDD Arc fault detection units [See page 3/59](#)
- AS Auxiliary switches [See page 3/50](#)
- FC Fault signal contacts [See page 3/52](#)
- AS+FC Auxiliary switches and fault signal contacts [See page 3/53](#)
- ST Shunt trips [See page 3/56](#)
- UR Undervoltage releases [See page 3/57](#)
- RC mech. Remote control mechanisms [See page 3/58](#)



3P+N		4P	
400 V AC		400 V AC	
4 MW		4 MW	
Characteristic		Characteristic	
C	D	C	D
5SY8614-7	5SY8614-8	5SY8414-7	5SY8414-8
5SY8605-7	5SY8605-8	5SY8405-7	5SY8405-8
5SY8601-7	5SY8601-8	5SY8401-7	5SY8401-8
5SY8615-7	5SY8615-8	5SY8415-7	5SY8415-8
5SY8602-7	5SY8602-8	5SY8402-7	5SY8402-8
5SY8603-7	5SY8603-8	5SY8403-7	5SY8403-8
5SY8604-7	5SY8604-8	5SY8404-7	5SY8404-8
5SY8606-7	5SY8606-8	5SY8406-7	5SY8406-8
5SY8608-7	5SY8608-8	5SY8408-7	5SY8408-8
5SY8610-7	5SY8610-8	5SY8410-7	5SY8410-8
–	–	–	–
5SY8613-7	5SY8613-8	5SY8413-7	5SY8413-8
5SY8616-7	5SY8616-8	5SY8416-7	5SY8416-8
5SY8620-7	5SY8620-8	5SY8420-7	5SY8420-8
5SY8625-7	5SY8625-8	5SY8425-7	5SY8425-8
5SY8632-7	5SY8632-8	5SY8432-7	5SY8432-8
5SY8640-7	5SY8640-8	5SY8440-7	5SY8440-8
5SY8650-7	5SY8650-8	5SY8450-7	5SY8450-8
5SY8663-7	5SY8663-8	5SY8463-7	5SY8463-8

Accessories

Auxiliary switches (AS)		Article No.	Undervoltage releases (UR)		Article No.
1 NO + 1 NC	Standard	5ST3010	With integrated auxiliary switch	230 V AC	5ST3040
	For low power	5ST3013		110 V DC	5ST3041
	For low power (with diode)	5ST3013-0XX01		24 V DC	5ST3042
2 NO	Standard	5ST3011	Without integrated auxiliary switch	230 V AC	5ST3043
	For low power	5ST3014		110 V DC	5ST3044
2 NC	Standard	5ST3012		24 V DC	5ST3045
	For low power	5ST3015			
1 CO	Standard	5ST3016	Remote control mechanisms (RC mech.)		Article No.
Fault signal contacts (FC)		Article No.	Basic	12 ... 30 V AC, 12 ... 48 V DC	5ST3053
1 NO + 1 NC		5ST3020		177 ... 270 V AC	5ST3054
2 NO		5ST3021	Power	12 ... 30 V AC, 12 ... 48 V DC	5ST3055
2 NC		5ST3022		177 ... 270 V AC	5ST3056
Auxiliary switches and fault signal contacts (AS+FC)		Article No.	Power with ARD	12 ... 30 V AC, 12 ... 48 V DC	5ST3057
1 CO (AS) + 1 CO (FC)		5ST3062		177 ... 270 V AC	5ST3058
5ST3 COM (AS+FC)		5ST3062-0MC	Power with extended function	12 ... 30 V AC, 12 ... 48 V DC	5ST3070
				170 ... 277 V AC, 77 ... 286 V DC	5ST3071
Shunt trips (ST)		Article No.	Adapters for remote control mechanisms (RC mech.)		Article No.
110 ... 415 V AC, 110 ... 220 V DC		5ST3030	1 ... 2 MW		5ST3820-1
24 ... 48 V AC/DC		5ST3031	3 ... 4 MW		5ST3820-2
12 V DC		5ST3031-0XX01			

5SJ4..HG.. miniature circuit breakers

According to UL489, 14/10 kA

Rated voltage U_n Mounting width	1P "same polarity only"			1P			
	240 V AC	240 V AC	240 V AC	240 V AC	480Y/277 V AC	240 V AC	480Y/277 V AC
1 MW							
Rated current I_n	Characteristic			Characteristic			
	B	C	D	C	C	D	D
0.3 A	–	5SJ4114-7HG40	5SJ4114-8HG40	5SJ4114-7HG41	5SJ4114-7HG42	5SJ4114-8HG41	5SJ4114-8HG42
0.5 A	–	5SJ4105-7HG40	5SJ4105-8HG40	5SJ4105-7HG41	5SJ4105-7HG42	5SJ4105-8HG41	5SJ4105-8HG42
1 A	–	5SJ4101-7HG40	5SJ4101-8HG40	5SJ4101-7HG41	5SJ4101-7HG42	5SJ4101-8HG41	5SJ4101-8HG42
1.6 A	–	5SJ4115-7HG40	5SJ4115-8HG40	5SJ4115-7HG41	5SJ4115-7HG42	5SJ4115-8HG41	5SJ4115-8HG42
2 A	–	5SJ4102-7HG40	5SJ4102-8HG40	5SJ4102-7HG41	5SJ4102-7HG42	5SJ4102-8HG41	5SJ4102-8HG42
3 A	–	5SJ4103-7HG40	5SJ4103-8HG40	5SJ4103-7HG41	5SJ4103-7HG42	5SJ4103-8HG41	5SJ4103-8HG42
4 A	–	5SJ4104-7HG40	5SJ4104-8HG40	5SJ4104-7HG41	5SJ4104-7HG42	5SJ4104-8HG41	5SJ4104-8HG42
5 A	–	5SJ4111-7HG40	5SJ4111-8HG40	5SJ4111-7HG41	5SJ4111-7HG42	5SJ4111-8HG41	5SJ4111-8HG42
6 A	5SJ4106-6HG40	5SJ4106-7HG40	5SJ4106-8HG40	5SJ4106-7HG41	5SJ4106-7HG42	5SJ4106-8HG41	5SJ4106-8HG42
8 A	–	5SJ4108-7HG40	5SJ4108-8HG40	5SJ4108-7HG41	5SJ4108-7HG42	5SJ4108-8HG41	5SJ4108-8HG42
10 A	5SJ4110-6HG40	5SJ4110-7HG40	5SJ4110-8HG40	5SJ4110-7HG41	5SJ4110-7HG42	5SJ4110-8HG41	5SJ4110-8HG42
13 A	5SJ4113-6HG40	5SJ4113-7HG40	5SJ4113-8HG40	5SJ4113-7HG41	5SJ4113-7HG42	5SJ4113-8HG41	5SJ4113-8HG42
15 A	5SJ4118-6HG40	5SJ4118-7HG40	5SJ4118-8HG40	5SJ4118-7HG41	5SJ4118-7HG42	5SJ4118-8HG41	5SJ4118-8HG42
16 A	5SJ4116-6HG40	5SJ4116-7HG40	5SJ4116-8HG40	5SJ4116-7HG41	5SJ4116-7HG42	5SJ4116-8HG41	5SJ4116-8HG42
20 A	5SJ4120-6HG40	5SJ4120-7HG40	5SJ4120-8HG40	5SJ4120-7HG41	5SJ4120-7HG42	5SJ4120-8HG41	5SJ4120-8HG42
25 A	5SJ4125-6HG40	5SJ4125-7HG40	5SJ4125-8HG40	5SJ4125-7HG41	5SJ4125-7HG42	5SJ4125-8HG41	5SJ4125-8HG42
30 A	5SJ4130-6HG40	5SJ4130-7HG40	5SJ4130-8HG40	5SJ4130-7HG41	5SJ4130-7HG42	5SJ4130-8HG41	5SJ4130-8HG42
32 A	5SJ4132-6HG40	5SJ4132-7HG40	5SJ4132-8HG40	5SJ4132-7HG41	5SJ4132-7HG42	5SJ4132-8HG41	5SJ4132-8HG42
35 A	5SJ4135-6HG40	5SJ4135-7HG40	5SJ4135-8HG40	5SJ4135-7HG41	5SJ4135-7HG42	5SJ4135-8HG41	–
40 A	5SJ4140-6HG40	5SJ4140-7HG40	5SJ4140-8HG40	5SJ4140-7HG41	5SJ4140-7HG42	5SJ4140-8HG41	–
45 A	5SJ4145-6HG40	5SJ4145-7HG40	5SJ4145-8HG40	5SJ4145-7HG41	–	5SJ4145-8HG41	–
50 A	5SJ4150-6HG40	5SJ4150-7HG40	5SJ4150-8HG40	5SJ4150-7HG41	–	5SJ4150-8HG41	–
60 A	5SJ4160-6HG40	5SJ4160-7HG40	5SJ4160-8HG40	5SJ4160-7HG41	–	5SJ4160-8HG41	–
63 A	5SJ4163-6HG40	5SJ4163-7HG40	5SJ4163-8HG40	5SJ4163-7HG41	–	5SJ4163-8HG41	–

Mounting concept

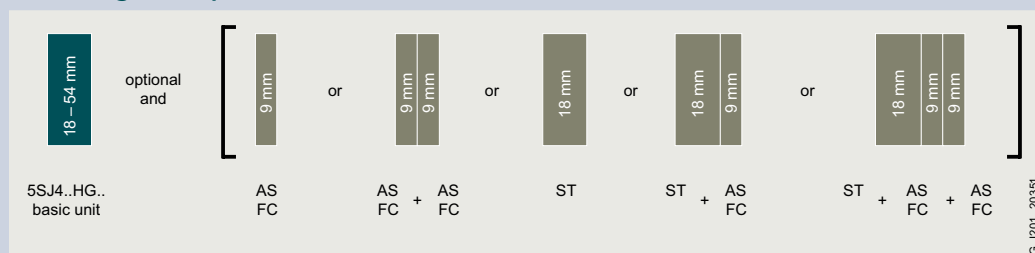

AS Auxiliary switches [See page 3/50](#)
 FC Fault signal contacts [See page 3/52](#)
 ST Shunt trips [See page 3/56](#)



2P				3P			
240 V AC	480Y/277 V AC	240 V AC	480Y/277 V AC	240 V AC	480Y/277 V AC	240 V AC	480Y/277 V AC
2 MW				3 MW			
Characteristic				Characteristic			
C	C	D	D	C	C	D	D
5SJ4214-7HG41	5SJ4214-7HG42	5SJ4214-8HG41	5SJ4214-8HG42	5SJ4314-7HG41	5SJ4314-7HG42	5SJ4314-8HG41	5SJ4314-8HG42
5SJ4205-7HG41	5SJ4205-7HG42	5SJ4205-8HG41	5SJ4205-8HG42	5SJ4305-7HG41	5SJ4305-7HG42	5SJ4305-8HG41	5SJ4305-8HG42
5SJ4201-7HG41	5SJ4201-7HG42	5SJ4201-8HG41	5SJ4201-8HG42	5SJ4301-7HG41	5SJ4301-7HG42	5SJ4301-8HG41	5SJ4301-8HG42
5SJ4215-7HG41	5SJ4215-7HG42	5SJ4215-8HG41	5SJ4215-8HG42	5SJ4315-7HG41	5SJ4315-7HG42	5SJ4315-8HG41	5SJ4315-8HG42
5SJ4202-7HG41	5SJ4202-7HG42	5SJ4202-8HG41	5SJ4202-8HG42	5SJ4302-7HG41	5SJ4302-7HG42	5SJ4302-8HG41	5SJ4302-8HG42
5SJ4203-7HG41	5SJ4203-7HG42	5SJ4203-8HG41	5SJ4203-8HG42	5SJ4303-7HG41	5SJ4303-7HG42	5SJ4303-8HG41	5SJ4303-8HG42
5SJ4204-7HG41	5SJ4204-7HG42	5SJ4204-8HG41	5SJ4204-8HG42	5SJ4304-7HG41	5SJ4304-7HG42	5SJ4304-8HG41	5SJ4304-8HG42
5SJ4211-7HG41	5SJ4211-7HG42	5SJ4211-8HG41	5SJ4211-8HG42	5SJ4311-7HG41	5SJ4311-7HG42	5SJ4311-8HG41	5SJ4311-8HG42
5SJ4206-7HG41	5SJ4206-7HG42	5SJ4206-8HG41	5SJ4206-8HG42	5SJ4306-7HG41	5SJ4306-7HG42	5SJ4306-8HG41	5SJ4306-8HG42
5SJ4208-7HG41	5SJ4208-7HG42	5SJ4208-8HG41	5SJ4208-8HG42	5SJ4308-7HG41	5SJ4308-7HG42	5SJ4308-8HG41	5SJ4308-8HG42
5SJ4210-7HG41	5SJ4210-7HG42	5SJ4210-8HG41	5SJ4210-8HG42	5SJ4310-7HG41	5SJ4310-7HG42	5SJ4310-8HG41	5SJ4310-8HG42
5SJ4213-7HG41	5SJ4213-7HG42	5SJ4213-8HG41	5SJ4213-8HG42	5SJ4313-7HG41	5SJ4313-7HG42	5SJ4313-8HG41	5SJ4313-8HG42
5SJ4218-7HG41	5SJ4218-7HG42	5SJ4218-8HG41	5SJ4218-8HG42	5SJ4318-7HG41	5SJ4318-7HG42	5SJ4318-8HG41	5SJ4318-8HG42
5SJ4216-7HG41	5SJ4216-7HG42	5SJ4216-8HG41	5SJ4216-8HG42	5SJ4316-7HG41	5SJ4316-7HG42	5SJ4316-8HG41	5SJ4316-8HG42
5SJ4220-7HG41	5SJ4220-7HG42	5SJ4220-8HG41	5SJ4220-8HG42	5SJ4320-7HG41	5SJ4320-7HG42	5SJ4320-8HG41	5SJ4320-8HG42
5SJ4225-7HG41	5SJ4225-7HG42	5SJ4225-8HG41	5SJ4225-8HG42	5SJ4325-7HG41	5SJ4325-7HG42	5SJ4325-8HG41	5SJ4325-8HG42
5SJ4230-7HG41	5SJ4230-7HG42	5SJ4230-8HG41	5SJ4230-8HG42	5SJ4330-7HG41	5SJ4330-7HG42	5SJ4330-8HG41	5SJ4330-8HG42
5SJ4232-7HG41	5SJ4232-7HG42	5SJ4232-8HG41	5SJ4232-8HG42	5SJ4332-7HG41	5SJ4332-7HG42	5SJ4332-8HG41	5SJ4332-8HG42
5SJ4235-7HG41	5SJ4235-7HG42	5SJ4235-8HG41	–	5SJ4335-7HG41	5SJ4335-7HG42	5SJ4335-8HG41	–
5SJ4240-7HG41	5SJ4240-7HG42	5SJ4240-8HG41	–	5SJ4340-7HG41	5SJ4340-7HG42	5SJ4340-8HG41	–
5SJ4245-7HG41	–	5SJ4245-8HG41	–	5SJ4345-7HG41	–	5SJ4345-8HG41	–
5SJ4250-7HG41	–	5SJ4250-8HG41	–	5SJ4350-7HG41	–	5SJ4350-8HG41	–
5SJ4260-7HG41	–	5SJ4260-8HG41	–	5SJ4360-7HG41	–	5SJ4360-8HG41	–
5SJ4263-7HG41	–	5SJ4263-8HG41	–	5SJ4363-7HG41	–	5SJ4363-8HG41	–

Accessories

Auxiliary switches (AS) acc. to UL 489	Article No.
1 NO + 1 NC	5ST3010-OHG
2 NO	5ST3011-OHG
2 NC	5ST3012-OHG
Fault signal contacts (FC) acc. to UL 489	Article No.
1 NO + 1 NC	5ST3020-OHG
2 NO	5ST3021-OHG
2 NC	5ST3022-OHG
Shunt trips (ST) acc. to UL 489	Article No.
110 ... 415 V AC, 110 ... 220 V DC	5ST3030-OHG
24 ... 48 V AC/DC	5ST3031-OHG

5SL6 COM miniature circuit breakers with communication and measuring function

With energy monitoring (EM), 1P+N 6 kA compact miniature circuit breakers

3

1P+N (N pole right)		
Rated voltage U_n	230 V AC	
Mounting width	1 MW	
Rated current I_n	Characteristic B	Characteristic C
2 A	5SL6002-6MC	5SL6002-7MC
4 A	5SL6004-6MC	5SL6004-7MC
6 A	5SL6006-6MC	5SL6006-7MC
8 A	–	5SL6008-7MC
10 A	5SL6010-6MC	5SL6010-7MC
13 A	5SL6013-6MC	5SL6013-7MC
16 A	5SL6016-6MC	5SL6016-7MC
20 A	5SL6020-6MC	5SL6020-7MC
25 A	5SL6025-6MC	5SL6025-7MC
32 A	5SL6032-6MC	5SL6032-7MC

Note:

Please note the country-specific radio licenses of the products at

www.siemens.com/lowvoltage/certificates (109801197)

Mounting concept

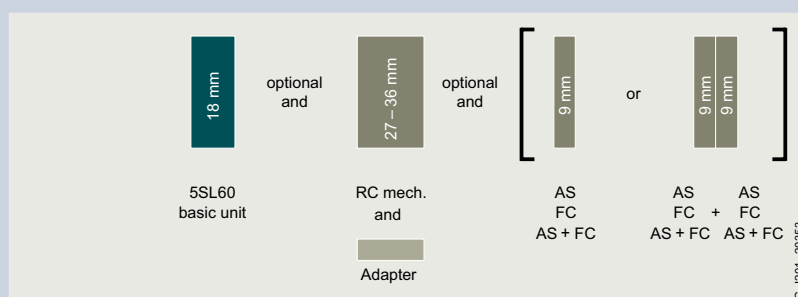
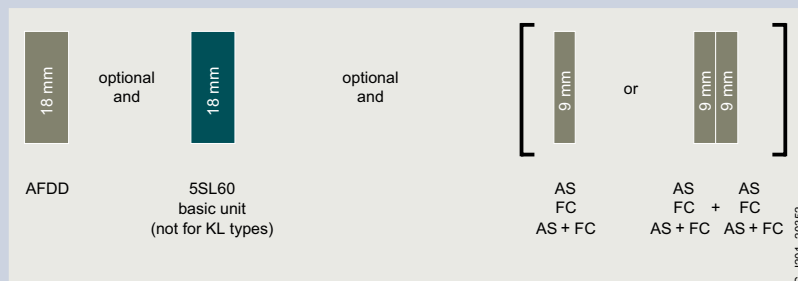

AFDD Arc fault detection units
 AS Auxiliary switches
 FC Fault signal contacts
 AS+FC Auxiliary switches and fault signal contacts
 RC mech. Remote control mechanisms

See page 3/59
 See page 3/50
 See page 3/52
 See page 3/53
 See page 3/58

Accessories

Auxiliary switches (AS)		Article No.
1 NO + 1 NC	Standard	5ST3010
	For low power	5ST3013
	For low power (with diode)	5ST3013-0XX01
2 NO	Standard	5ST3011
	For low power	5ST3014
2 NC	Standard	5ST3012
	For low power	5ST3015
1 CO	Standard	5ST3016
Fault signal contacts (FC)		Article No.
1 NO + 1 NC		5ST3020
2 NO		5ST3021
2 NC		5ST3022
Auxiliary switches and fault signal contacts (AS+FC)		Article No.
1 CO (AS) + 1 CO (FC)		5ST3062
5ST3 COM (AS+FC)		5ST3062-0MC

Remote control mechanisms (RC mech.)		Article No.
Basic	12 ... 30 V AC, 12 ... 48 V DC	5ST3053
	177 ... 270 V AC	5ST3054
Power	12 ... 30 V AC, 12 ... 48 V DC	5ST3055
	177 ... 270 V AC	5ST3056
Power with ARD	12 ... 30 V AC, 12 ... 48 V DC	5ST3057
	177 ... 270 V AC	5ST3058
Power with extended function	12 ... 30 V AC, 12 ... 48 V DC	5ST3070
	170 ... 277 V AC, 77 ... 286 V DC	5ST3071
Adapters for remote control mechanisms (RC mech.)		Article No.
1 MW		5ST3820-6
Arc fault detection units (AFDD)		Article No.
For basic units 1P + N (1 MW), not for KL types	I_n up to 16 A	5SM6011-2
	I_n up to 40 A	5SM6014-2
Data transceiver (essential accessory)		Article No.
SENTRON Powercenter 1000		7KN1110-0MC00



SENTRON Powercenter 1000 data transceiver

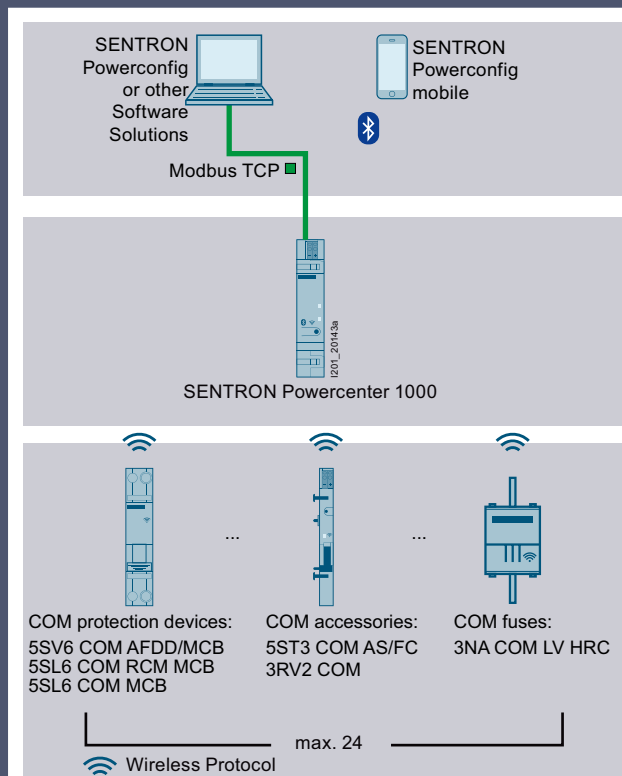

- Wireless radio transmission of measured values and data to the SENTRON Powercenter 1000 data transceiver
- Commissioning, parameter assignment, firmware updates and further processing of the data via the SENTRON Powercenter 1000 data transceiver



SENTRON Powercenter 1000

Article No.

7KN1110-0MC00

See page 10/20

You will find further information at www.siemens.com/lowvoltage/manuals

Installation Manual – Circuit protection devices with communication and measuring function (109791805)



System Manual – Circuit protection devices with communication and measuring function (109791806)



Monitoring functions with limit monitoring

- Switching state with trip monitoring: short-circuit, overload
- Counters incl. limit monitoring for:
 - Operating hours
 - Operating hours with load current
 - Operating cycles (ON/OFF)
 - Tripping operations
 - Short circuits
- Limit values for:
 - Overcurrent alarm 1 and alarm 2
 - Undercurrent alarm 1 and alarm 2
 - Temperature

Measured values	Unit	Memory
Temperature	°C	1 hour in 1-minute intervals; 7 days in 15-minute intervals
Average temperature	°C	–
Current	A	Min. and max. values over 10 days; 1 hour in 10-second intervals; 7 days in 15-minute intervals
Average current	A	–
Maximum current	A	–
Voltage	V	Min. and max. values over 10 days
Line frequency	Hz	Min. and max. values over 10 days
Active power	W	Min. and max. values over 10 days
Apparent power	VA	Min. and max. values over 10 days
Reactive power	Var	–
Power factor		–
Active energy imported	Wh	7 days in 15-minute intervals; 30 days in 1-day intervals
Active energy exported	Wh	–
Reactive energy imported	Varh	–
Reactive energy exported	Varh	–

5SL6 COM miniature circuit breakers with communication and measuring function

With residual current monitoring (RCM) and energy monitoring (EM),
1P+N 6 kA compact miniature circuit breakers

1P+N (N pole right)	
Rated voltage U_n	230 V AC
Mounting width	1 MW
Rated current I_n	Characteristic
	B C
2 A	– 5SL6002-7MF
4 A	– 5SL6004-7MF
6 A	5SL6006-6MF 5SL6006-7MF
8 A	– 5SL6008-7MF
10 A	5SL6010-6MF 5SL6010-7MF
13 A	5SL6013-6MF 5SL6013-7MF
16 A	5SL6016-6MF 5SL6016-7MF
20 A	5SL6020-6MF 5SL6020-7MF
25 A	5SL6025-6MF 5SL6025-7MF
32 A	5SL6032-6MF 5SL6032-7MF

Note:

Please note the country-specific radio licenses of the products at
www.siemens.com/lowvoltage/certificates
(109801197)

Mounting concept

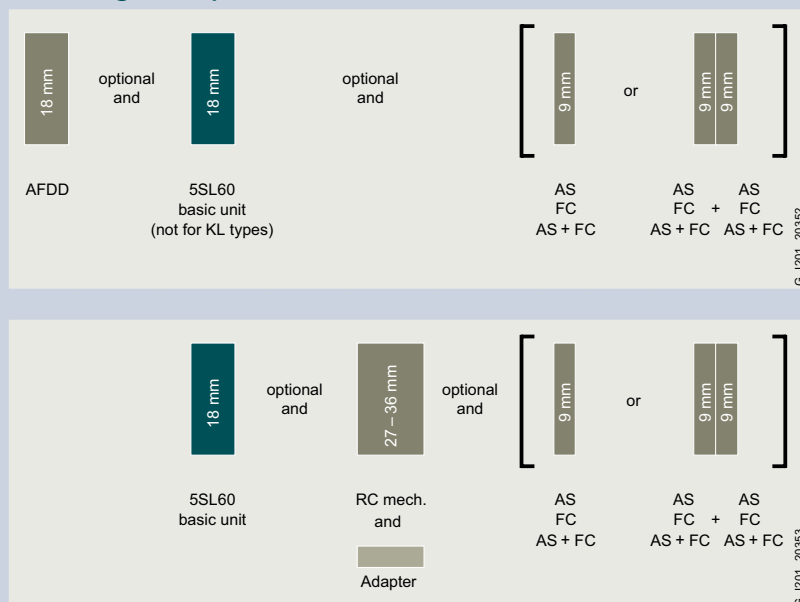

AFDD Arc fault detection units
AS Auxiliary switches
FC Fault signal contacts
AS+FC Auxiliary switches and fault signal contacts
RC mech. Remote control mechanisms

See page 3/59
See page 3/50
See page 3/52
See page 3/53
See page 3/58

Accessories

Auxiliary switches (AS)		Article No.
1 NO + 1 NC	Standard	5ST3010
	For low power	5ST3013
	For low power (with diode)	5ST3013-0XX01
2 NO	Standard	5ST3011
	For low power	5ST3014
2 NC	Standard	5ST3012
	For low power	5ST3015
1 CO	Standard	5ST3016
Fault signal contacts (FC)		Article No.
1 NO + 1 NC		5ST3020
2 NO		5ST3021
2 NC		5ST3022
Auxiliary switches and fault signal contacts (AS+FC)		Article No.
1 CO (AS) + 1 CO (FC)		5ST3062
5ST3 COM (AS+FC)		5ST3062-0MC

Remote control mechanisms (RC mech.)		Article No.
Basic	12 ... 30 V AC, 12 ... 48 V DC	5ST3053
	177 ... 270 V AC	5ST3054
Power	12 ... 30 V AC, 12 ... 48 V DC	5ST3055
	177 ... 270 V AC	5ST3056
Power with ARD	12 ... 30 V AC, 12 ... 48 V DC	5ST3057
	177 ... 270 V AC	5ST3058
Power with extended function	12 ... 30 V AC, 12 ... 48 V DC	5ST3070
	170 ... 277 V AC, 77 ... 286 V DC	5ST3071
Adapters for remote control mechanisms (RC mech.)		Article No.
1 MW		5ST3820-6
Arc fault detection units (AFDD)		Article No.
For basic units 1P + N	I_n up to 16 A	5SM6011-2
(1 MW), not for KL types	I_n up to 40 A	5SM6014-2
Data transceiver (essential accessory)		Article No.
SENTRON Powercenter 1000		7KN1110-0MC00

5SP3 selective main miniature circuit breakers (SHU)

25 kA, mounting on a 40 mm busbar

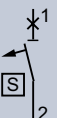
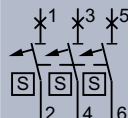

	1P	3 × 1P
Rated voltage U_n	230/400 V AC	230/400 V AC
Mounting width	1.5 MW	4.5 MW
		

Rated current I_n	Characteristic				Characteristic
	E	E			
	L1	L2	L3	L1 + L2 + L3	E
16 A	5SP3716-2KK01	5SP3716-2KK02	5SP3716-2KK03	5SP3716-2	5SP3816-2
20 A	5SP3720-2KK01	5SP3720-2KK02	5SP3720-2KK03	5SP3720-2	5SP3820-2
25 A	5SP3725-2KK01	5SP3725-2KK02	5SP3725-2KK03	5SP3725-2	5SP3825-2
35 A	5SP3735-2KK01	5SP3735-2KK02	5SP3735-2KK03	5SP3735-2	5SP3835-2
40 A	5SP3740-2KK01	5SP3740-2KK02	5SP3740-2KK03	5SP3740-2	5SP3840-2
50 A	5SP3750-2KK01	5SP3750-2KK02	5SP3750-2KK03	5SP3750-2	5SP3850-2
63 A	5SP3763-2KK01	5SP3763-2KK02	5SP3763-2KK03	5SP3763-2	5SP3863-2

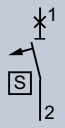
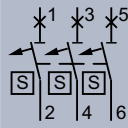
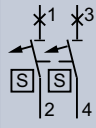
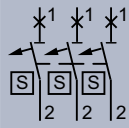
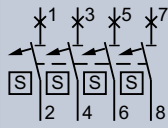

25 kA, mounting on a DIN rail

	1P	3 × 1P	2P	3P	4P
Rated voltage U_n	230/400 V AC	230/400 V AC	230/400 V AC	230/400 V AC	230/400 V AC
Mounting width	1.5 MW	4.5 MW	3 MW	4.5 MW	6 MW
					
Rated current I_n	Characteristic E	Characteristic E	Characteristic E	Characteristic E	Characteristic E
16 A	5SP3716-3	5SP3816-3	5SP3216-3	5SP3316-3	5SP3416-3
20 A	5SP3720-3	5SP3820-3	5SP3220-3	5SP3320-3	5SP3420-3
25 A	5SP3725-3	5SP3825-3	5SP3225-3	5SP3325-3	5SP3425-3
35 A	5SP3735-3	5SP3835-3	5SP3235-3	5SP3335-3	5SP3435-3
40 A	5SP3740-3	5SP3840-3	5SP3240-3	5SP3340-3	5SP3440-3
50 A	5SP3750-3	5SP3850-3	5SP3250-3	5SP3350-3	5SP3450-3
63 A	5SP3763-3	5SP3863-3	5SP3263-3	5SP3363-3	5SP3463-3

5SY17 circuit breakers for equipment

Electromechanical



1P+AS
 Rated voltage U_n 230 V AC/12 ... 72 V DC
 Mounting width 1 MW (18 mm)



Rated current I_n	Characteristic	
	F1 (quick)	F2 (slow)
0.5 A	5SY1705-2	5SY1705-4
1 A	5SY1701-2	5SY1701-4
2 A	5SY1702-2	5SY1702-4
4 A	5SY1704-2	5SY1704-4
6 A	5SY1706-2	5SY1706-4
8 A	5SY1708-2	5SY1708-4
10 A	5SY1710-2	5SY1710-4
16 A	5SY1716-2	5SY1716-4

Mounting concept

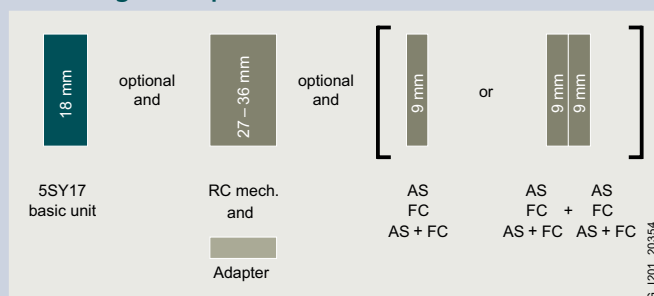

AS Auxiliary switches
 FC Fault signal contacts
 AS+FC Auxiliary switches and fault signal contacts
 RC mech. Remote control mechanisms

[See page 3/50](#)
[See page 3/52](#)
[See page 3/53](#)
[See page 3/58](#)

Accessories

Auxiliary switches (AS)		Article No.
1 NO + 1 NC	Standard	5ST3010
	For low power	5ST3013
	For low power (with diode)	5ST3013-0XX01
2 NO	Standard	5ST3011
	For low power	5ST3014
2 NC	Standard	5ST3012
	For low power	5ST3015
1 CO	Standard	5ST3016
Fault signal contacts (FC)		Article No.
1 NO + 1 NC		5ST3020
2 NO		5ST3021
2 NC		5ST3022

Auxiliary switches and fault signal contacts (AS+FC)		Article No.
1 CO (AS) + 1 CO (FC)		5ST3062
5ST3 COM (AS+FC)		5ST3062-0MC
Remote control mechanisms (RC mech.)		Article No.
Basic	12 ... 30 V AC, 12 ... 48 V DC	5ST3053
	177 ... 270 V AC	5ST3054
Power	12 ... 30 V AC, 12 ... 48 V DC	5ST3055
	177 ... 270 V AC	5ST3056
Power with ARD	12 ... 30 V AC, 12 ... 48 V DC	5ST3057
	177 ... 270 V AC	5ST3058
Power with extended function	12 ... 30 V AC, 12 ... 48 V DC	5ST3070
	170 ... 277 V AC, 77 ... 286 V DC	5ST3071
Adapters for remote control mechanisms (RC mech.)		Article No.
1 MW		5ST3820-6

5SK9 circuit breakers for equipment

Electronic



	1P+AS
Rated voltage U_n	24 V DC
Mounting width	6.2 mm

Rated current I_n	
1 A	5SK9101-1
2 A	5SK9102-1
3 A	5SK9103-1
4 A	5SK9104-1
6 A	5SK9106-1
8 A	5SK9108-1

3

Specific accessories

Connecting combs			
	Type	Number of poles	Max. load current I_{max}
	For parallel infeed	2-pole	32 A
	For remote signal – group signal	5-pole	32 A
		2-pole	32 A
			8WH9020-6CC10
			8WH9020-6CF10
			8WH9020-6CC10
Reducing combs for terminal blocks of 10 mm ²			
	Type	Number of poles	Max. load current I_{max}
	For bypassing the power supply	2-pole	40 A
			8WH9020-0AC10

See general accessories, from page 3/60 onwards

Overview of the modular system

Miniature circuit breakers

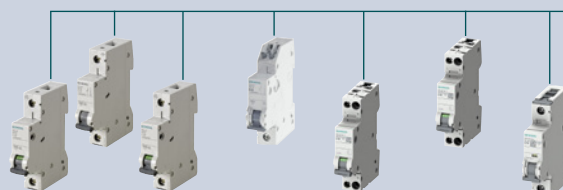

				5SL3	5SL6	5SL4	5SJ6...-KS	5SL30	5SL60/ 5SL6 COM	5SY
Auxiliary switches (AS)				Article No.						
	1 NO + 1 NC	Standard	5ST3010	■	■	■	–	■	■	■
		For low power	5ST3013	■	■	■	–	■	■	■
		For low power (with diode)	5ST3013-0XX01	■	■	■	–	■	■	■
	2 NO	Standard	5ST3011	■	■	■	–	■	■	■
		For low power	5ST3014	■	■	■	–	■	■	■
	2 NC	Standard	5ST3012	■	■	■	–	■	■	■
For low power		5ST3015	■	■	■	–	■	■	■	
1 CO	Standard	5ST3016	■	■	■	–	■	■	■	
		5ST1010-0FP	–	–	–	–	–	–	–	
Fault signal contacts (FC)				Article No.						
	1 NO + 1 NC		5ST3020	■	■	■	–	■	■	■
	2 NO		5ST3021	■	■	■	–	■	■	■
	2 NC		5ST3022	■	■	■	–	■	■	■
Auxiliary switches and fault signal contacts (AS+FC)				Article No.						
	1 CO (AS) + 1 CO (FC)	Standard	5ST3062	■	■	■	–	■	■	■
	5ST3 COM (AS+FC)	With communication and measuring function	5ST3062-0MC	■	■	■	–	■	■	■
Shunt trips (ST)				Article No.						
	110 ... 415 V AC, 110 ... 220 V DC		5ST3030	–	–	■	–	–	–	■
	24 ... 48 V AC/DC		5ST3031	–	–	■	–	–	–	■
	12 V DC		5ST3031-0XX01	–	–	■	–	–	–	■
Undervoltage releases (UR)				Article No.						
	With integrated auxiliary switch	230 V AC	5ST3040	–	–	■	–	–	–	■
		110 V DC	5ST3041	–	–	■	–	–	–	■
		24 V DC	5ST3042	–	–	■	–	–	–	■
	Without integrated auxiliary switch	230 V AC	5ST3043	–	–	■	–	–	–	■
		110 V DC	5ST3044	–	–	■	–	–	–	■
		24 V DC	5ST3045	–	–	■	–	–	–	■
Remote control mechanisms (RC mech.)				Article No.						
	Basic	12 ... 30 V AC, 12 ... 48 V DC	5ST3053	–	■	■	–	–	■	■
		177 ... 270 V AC	5ST3054	–	■	■	–	–	■	■
	Power	12 ... 30 V AC, 12 ... 48 V DC	5ST3055	–	■	■	–	–	■	■
		177 ... 270 V AC	5ST3056	–	■	■	–	–	■	■
	Power with ARD	12 ... 30 V AC, 12 ... 48 V DC	5ST3057	–	■	■	–	–	■	■
		177 ... 270 V AC	5ST3058	–	■	■	–	–	■	■
	Power with extended function	12 ... 30 V AC, 12 ... 48 V DC	5ST3070	–	■	■	–	–	■	■
		170 ... 277 V AC, 77 ... 286 V DC	5ST3071	–	■	■	–	–	■	■
5SM6 arc fault detection units				Article No.						
	Rated current up to 16 A	Standard	5SM6021-2	–	–	□	–	–	–	□
		For compact devices 1P+N in 1 MW	5SM6011-2	–	–	–	–	–	□	–
	Rated current up to 40 A	Standard	5SM6024-2	–	–	□	–	–	–	□
		For compact devices 1P+N in 1 MW	5SM6014-2	–	–	–	–	–	□	–
Standard busbars				Article No.						
	Cannot be cut		5ST36..	■	■	■	■	■	■	■
	Can be cut		5ST37..	■	■	■	■	■	■	■
Compact busbars				Article No.						
	Cannot be cut		5ST36..	□	□	□	–	■	■	–
	Can be cut		5ST37..	□	□	□	–	■	■	–

From page 3/12

■ Suitable for all versions

□ Suitable for some versions

Electrical accessories

Auxiliary switches (AS)



- Signals the contact position of the mounted device
- Version for the switching of small currents and voltages according to EN 61131-2 for control of programmable control systems (PLCs)
- Test button enables the testing of control circuits without the need to switch the mounted device

For combining with basic units						Contacts	Version	Mounting width (1 MW = 18 mm)	Article No.
Miniature circuit breakers	Circuit breakers for equipment	RCCBs	RCBOs	Arc fault detection devices	ON/OFF switches				
Auxiliary switches (AS)									
5SL, 5SY, 5SP4, 5SP5	5SY17	5SV	5SU1 ¹⁾ , 5SV1	5SV6	5TL1, 5TE8	1 NO + 1 NC	Standard	0.5 MW	5ST3010
							For low power	0.5 MW	5ST3013
							For low power (with diode)	0.5 MW	5ST3013-0XX01
						2 NO	Standard	0.5 MW	5ST3011
							For low power	0.5 MW	5ST3014
						2 NC	Standard	0.5 MW	5ST3012
							For low power	0.5 MW	5ST3015
						1 CO	Standard	0.5 MW	5ST3016
						Auxiliary switches (AS) with TEST button			
5SL, 5SY, 5SP4, 5SP5	5SY17	5SV	5SU1 ¹⁾ , 5SV1	5SV6	5TL1, 5TE8	1 NO + 1 NC	Standard	0.5 MW	5ST3010-2
							For low power	0.5 MW	5ST3013-2
						2 NO	Standard	0.5 MW	5ST3011-2
							For low power	0.5 MW	5ST3014-2
						2 NC	Standard	0.5 MW	5ST3012-2
							For low power	0.5 MW	5ST3015-2
Auxiliary switches (AS) acc. to UL 489									
5SJ4...-HG	-	-	-	-	-	1 NO + 1 NC	Standard	0.5 MW	5ST3010-0HG
						2 NO	Standard	0.5 MW	5ST3011-0HG
						2 NC	Standard	0.5 MW	5ST3012-0HG

¹⁾ 5ST3805-1 handle coupler required

Further technical specifications

5ST3010,
5ST3011,
5ST3012,
5ST30165ST3010-0HG,
5ST3011-0HG,
5ST3012-0HG5ST3010-2,
5ST3011-2,
5ST3012-25ST3013,
5ST3014,
5ST3015,
5ST3013-0XX01¹⁾5ST3013-2,
5ST3014-2,
5ST3015-2

Standards				
Standards	IEC/EN	IEC/EN 62019, IEC/EN 60947-5-1	–	IEC/EN 62019, IEC/EN 60947-5-1
	UL, CSA	UL 1077, CSA C22.2 No. 235	UL 489, CSA 22.2 No. 5-02	– UL 1077, CSA C22.2 No. 235
Contacts				
Minimum contact load		50 mA, 24 V		1 mA, 5 V DC 5 mA, 5 V DC
Maximum contact load		–		100 mA, 30 V DC 50 mA, 30 V DC
Contact load acc. to IEC/EN 62019/ IEC/EN 60947-5-1	230 V AC, AC-12	–		–
	230 V AC, AC-13	6 A/6 A		–
	400 V AC, AC-13	2 A/2 A		–
	230 V AC, AC-14	6 A/6 A		–
	400 V AC, AC-14	2 A/2 A		–
	24 V DC, DC-13	6 A/3 A		–
	30 V DC, DC-14	–		0.1 A
	60 V DC, DC-13	3 A/1.5 A		–
	110 V DC, DC-13	1 A/0.75 A		–
	220 V DC, DC-12	–		–
	220 V DC, DC-13	1 A/0.5 A		–
	Contact load acc. to UL	120 V AC	–	6 A
125 V AC		3 A	–	–
240 V AC		4 A	–	–
277 V AC		–	3 A	–
480 V AC		1.5 A	–	–
60 V DC		–	3 A	–
125 V DC		1.1 A	1 A	–
250 V DC		0.55 A	–	–
Service life, on average, with rated load	Actuations	20000	12000	20000
Safety				
Short-circuit protection		5SY... 6A miniature circuit breaker or gG 6 A fuse		
Connections				
Conductor cross-sections		0.5 ... 2.5 mm ² (AWG 22 ... 14)		
Terminals	Max. tightening torque	0.5 Nm (4.5 lb-in)		
Ambient conditions				
Permissible ambient temperature		–40 ... +70 °C		
Permissible storage temperature		–40 ... +75 °C		
Resistance to climate	Acc. to IEC 60068-2-30	28 cycles		
Mounting position		Any		
Shock at 11 ms half-sine	Acc. to IEC 60068-2-27	150 m/s ²		
Resistance to vibrations at 5 ... 150 Hz	Acc. to IEC 60068-2-6	50 m/s ²		

¹⁾ No approvals

Electrical accessories



Fault signal contacts (FC)

- Signals automatic tripping of the circuit protection device in the event of a fault, such as an overload or a short circuit
- If the fault signal contact is activated, the contact position does not change if the mounted circuit protection device is tripped manually
- Version with TEST and RESET buttons enables the testing of control circuits without operation of the circuit protection device
- Red RESET button in the operating handle indicates automatic tripping of the mounted circuit protection device

3

For combining with basic units					Contacts	Mounting width (1 MW = 18 mm)	Article No.
Miniature circuit breakers	Circuit breakers for equipment	RCCBs	RCBOs	Arc fault detection devices			
Fault signal contacts (FC)							
5SL, 5SY, 5SP4, 5SP5	5SY17	5SV	5SU1 ¹⁾ , 5SV1	5SV6	1 NO + 1 NC	0.5 MW	5ST3020
					2 NO	0.5 MW	5ST3021
					2 NC	0.5 MW	5ST3022
Fault signal contacts (FC) with TEST and RESET button							
5SL, 5SY, 5SP4, 5SP5	5SY17	5SV	5SU1 ¹⁾ , 5SV1	5SV6	1 NO + 1 NC	0.5 MW	5ST3020-2
					2 NO	0.5 MW	5ST3021-2
					2 NC	0.5 MW	5ST3022-2
Fault signal contacts (FC) acc. to UL 489							
5SJ4...-HG	–	–	–	–	1 NO + 1 NC	0.5 MW	5ST3020-0HG
					2 NO	0.5 MW	5ST3021-0HG
					2 NC	0.5 MW	5ST3022-0HG

¹⁾ 5ST3805-1 handle coupler required

Further technical specifications

	5ST3020, 5ST3021, 5ST3022	5ST3020-2, 5ST3021-2, 5ST3022-2	5ST3020-0HG, 5ST3021-0HG, 5ST3022-0HG
Standards			
Standards	IEC/EN UL, CSA	IEC/EN 62019, IEC/EN 60947-5-1 UL 1077, CSA C22.2 No. 235	– UL 489, CSA 22.2 No. 5-02
Contacts			
Minimum contact load	50 mA, 24 V		
Contact load acc. to IEC/EN 62019/IEC/EN 60947-5-1	230 V AC, AC-13 400 V AC, AC-13 230 V AC, AC-14 400 V AC, AC-14 24 V DC, DC-13 60 V DC, DC-13 110 V DC, DC-13 220 V DC, DC-13	6 A/6 A 6 A/6 A 2 A/2 A 2 A/2 A 6 A/3 A 3 A/1.5 A 1 A/0.75 A 1 A/0.5 A	
Contact load acc. to UL	120 V AC 125 V AC 240 V AC 277 V AC 480 V AC 60 V DC 125 V DC 250 V DC	– 3 A 4 A – 1.5 A – 1.1 A 0.55 A	6 A – – 3 A – 3 A 1 A –
Service life, on average, with rated load	Actuations	20000	12000
Safety			
Short-circuit protection	Miniature circuit breaker or gG 6 A fuse		
Connections			
Conductor cross-sections	0.5 ... 2.5 mm ² (AWG 22 ... 14)		
Terminals	Max. tightening torque	0.5 Nm (4.5 lb-in)	
Ambient conditions			
Permissible ambient temperature	–25 ... +55 °C		
Permissible storage temperature	–40 ... +75 °C		
Resistance to climate	Acc. to IEC 60068-2-30	28 cycles	
Mounting position	Any		
Shock at 11 ms half-sine	Acc. to IEC 60068-2-27	150 m/s ²	
Resistance to vibrations at 10 ... 150 Hz	Acc. to IEC 60068-2-6	50 m/s ²	



Auxiliary switches and fault signal contacts (AS+FC)

- Combines the function of both switches in a width of only 0.5 MW (9 mm)
- Signals the contact position of the mounted circuit protection device
- Signals automatic tripping of the circuit protection device in the event of a fault, such as an overload, a short circuit or a fault current
- If the fault signal contact is activated, the contact position does not change if the mounted circuit protection device is tripped manually

For combining with basic units					Contacts	Mounting width (1 MW = 18 mm)	Article No.
Miniature circuit breakers	Circuit breakers for equipment	RCCBs	RCBOs	Arc fault detection devices			
Auxiliary switches and fault signal contacts (AS+FC)							
5SL, 5SY, 5SP4, 5SP5	5SY17	5SV	5SU1 ¹⁾ , 5SV1	5SV6	1 CO (AS) + 1 CO (FC)	0.5 MW	5ST3062

¹⁾ 5ST3805-1 handle coupler required

Further technical specifications

5ST3062

Standards		
Standards	IEC/EN UL, CSA	IEC/EN 62019, IEC/EN 60947-5-1 UL 1077, CSA C22.2 No. 235
Contacts		
Minimum contact load		50 mA, 24 V
Maximum contact load		–
Contact load acc. to IEC/EN 62019/IEC/EN 60947-5-1	230 V AC, AC-13	6 A/6 A
	400 V AC, AC-14	2 A/2 A
Contact load acc. to IEC/EN 62019/IEC/EN 60947-5-1	24 V DC, DC-13	3 A/3 A
	60 V DC, DC-13	3 A/1 A
	110 V DC, DC-13	0.5 A/0.5 A
	220 V DC, DC-13	0.5 A/0.3 A
Contact load acc. to UL	125 V AC	2 A
	240 V AC	1.5 A
	480 V AC	0.75 A
	125 V DC	0.5 A
	250 V DC	0.3 A
Service life, on average, with rated load	Actuations	20000
Safety		
Short-circuit protection		Miniature circuit breaker or gG 6 A fuse
Connections		
Conductor cross-sections		0.5 ... 2.5 mm ² (AWG 22 ... 14)
Terminals	Max. tightening torque	0.5 Nm (4.5 lb-in)
Ambient conditions		
Permissible ambient temperature		–25 ... +55 °C
Permissible storage temperature		–40 ... +75 °C
Resistance to climate	Acc. to IEC 60068-2-30	28 cycles
Mounting position		Any
Shock at 11 ms half-sine	Acc. to IEC 60068-2-27	150 m/s ²
Resistance to vibrations at 10 ... 150 Hz	Acc. to IEC 60068-2-6	50 m/s ²

Electrical accessories



5ST3 COM auxiliary switches and fault signal contacts (AS+FC) with communication and measuring function

- Reports the switching state of the mounted standard circuit protection device (ON, tripped, manual OFF, tripped with locked handle)
- Measures the temperature of the device and counts operating cycles, trips and operating hours
- Communication via radio to SENTRON Powercenter 1000 data transceiver
- Plug-in terminals for 24 V DC power supply incl. daisy chain function
- Low space requirements of 0.5 MW (9 mm)

For combining with basic units					Mounting width (1 MW = 18 mm)	Article No.
Miniature circuit breakers	Circuit breakers for equipment	RCCBs	RCBOs	Arc fault detection devices	Communication	
5ST3 COM auxiliary switches and fault signal contacts (AS+FC) with communication and measuring function						
5SL, 5SY, 5SP4, 5SP5	5SY17	5SV	5SU1 ¹⁾ , 5SV1	5SV6	Radio link to SENTRON Powercenter 1000	0.5 MW 5ST3062-0MC

¹⁾ 5ST3805-1 handle coupler required

Note:

Please note the country-specific radio licenses of the products at www.siemens.com/lowvoltage/certificates (109801197)

Further technical specifications

5ST3062-0MC

Standards		
Standards	IEC/EN RED	60669-2-5 2014/53/EU
Power supply		
Power supply		24 V DC ±20%, SELV
Conductor cross-sections		0.2 ... 1.5 mm ²
Connection type		Plug-in terminal
Safety		
Degree of pollution for overvoltage category		2/II
Degree of protection		IP40, with front cover
Ambient conditions		
Permissible ambient temperature		-25 ... +60 °C
Permissible storage temperature		-40 ... +85 °C
Humidity		93% at 40 °C
Resistance to climate	Acc. to IEC 60068-2-30	28 cycles
Mounting position		Any
Shock		150 m/s ²
Resistance to vibrations at 10 ... 150 Hz	Acc. to IEC 60068-2-6	50 m/s ²
Service life/endurance		10000
Communication		
Interface	SETRON Powercenter 1000	Radio link
Temperature		Measuring accuracy of 2 °C with limit monitoring incl. storage (1 hour in 1-minute intervals and 7 days in 15-minute intervals)
Operating cycles counters		Mechanical operation with limit monitoring
Trip counter		Trip of the mounted circuit protection device with limit monitoring
Operating hours counter		Operating hours with limit monitoring



SENTRON Powercenter 1000 data transceiver

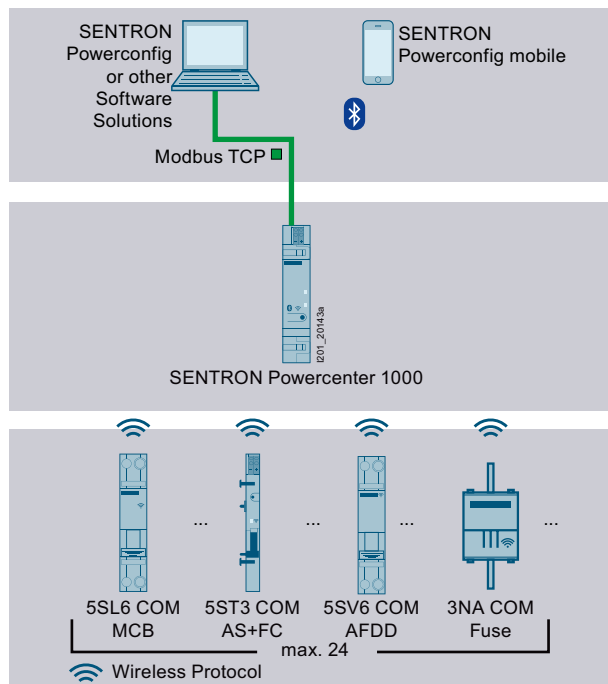

- Wireless radio transmission of measured values and data to the SENTRON Powercenter 1000 data transceiver
- Commissioning, parameter assignment, firmware updates and further processing of the data via the SENTRON Powercenter 1000 data transceiver



SENTRON Powercenter 1000	Article No.
	7KN1110-0MC00

See page 10/20

You will find further information at www.siemens.com/lowvoltage/manuals

Installation Manual – Circuit protection devices with communication and measuring function (109791805)



System Manual – Circuit protection devices with communication and measuring function (109791806)



Electrical accessories



Shunt trips (ST)

- For remote-controlled tripping of the mounted device

For combining with basic units			Rated operational voltage U_e	Mounting width (1 MW = 18 mm)	Article No.
Miniature circuit breakers	RCCBs	RCBOs			
Shunt trips (ST)					
5SL4, 5SY, 5SP	5SV	5SU1 ¹⁾	110 ... 415 V AC, 110 ... 220 V DC	1 MW	5ST3030
			24 ... 48 V AC/DC	1 MW	5ST3031
			12 V DC	1 MW	5ST3031-0XX01
Shunt trips (ST) acc. to UL 489					
5SJ4...-HG	–	–	110 ... 415 V AC, 110 ... 220 V DC	1 MW	5ST3030-OHG
			24 ... 60 V AC/DC	1 MW	5ST3031-OHG

¹⁾ 5ST3805-1 handle coupler required

Further technical specifications

	5ST3030	5ST3031	5ST3031-0XX01	5ST3030-OHG	5ST3031-OHG
Standards					
Standards	IEC/EN UL, CSA		EN 60947-1 –	IEC/EN 60947-1 UL 489, UL-File E321559, CSA 22.2 No. 5-02	
Supply					
Primary operating range	0.7 ... 1.1 × U_n				
Rated frequency f_n	50 ... 60 Hz		–	50 ... 60 Hz	
Contacts					
Minimum contact load	50 mA, 24 V		1 mA, 5 V	50 mA, 24 V	
Tripping operations	Max. 2000				
Service life, on average, with rated load	Actuations 20000			12000	
Safety					
Short-circuit protection	Miniature circuit breaker B/C 6 A or fuse gG 6 A				
Connections					
Conductor cross-sections	0.5 ... 2.5 mm ² (AWG 22 ... 14)				
Terminals	Max. tightening torque 0.8 Nm (6.8 lb-in)				
Ambient conditions					
Permissible ambient temperature	–25 ... +55 °C		–40 ... +70 °C	–25 ... +55 °C	
Permissible storage temperature	–40 ... +75 °C				
Resistance to climate	Acc. to IEC 60068-2-30		28 cycles		
Mounting position	Any				
Shock at 11 ms half-sine	Acc. to IEC 60068-2-27		150 m/s ²		
Resistance to vibrations at 10 ... 150 Hz	Acc. to IEC 60068-2-6		50 m/s ²		



Undervoltage releases (UR)

- Are integrated (e.g. in EMERGENCY-OFF loops), thus ensuring that the MCB trips in the event of an emergency. EMERGENCY-OFF is a function provided to disconnect the electricity supply to all or some parts of the installation in case of emergency, when there is a risk of electric shock or any other hazard caused by electrical power
- In addition, an undervoltage release also trips if the voltage is interrupted or too low, or prevents the MCB from closing
- Combination with 5SV RCCB not suitable for implementation of EMERGENCY-OFF/ EMERGENCY-STOP circuits

For combining with basic units			Rated operational voltage U_e	Mounting width (1 MW = 18 mm)	Article No.
Miniature circuit breakers	RCCBs	RCBOs			
With integrated auxiliary switch					
5SL4, 5SY, 5SP4, 5SP5	5SV	5SU1 ¹⁾	230 V AC	1 MW	5ST3040
			110 V DC	1 MW	5ST3041
			24 V DC	1 MW	5ST3042
Without integrated auxiliary switch					
5SL4, 5SY, 5SP4, 5SP5	5SV	5SU1 ¹⁾	230 V AC	1 MW	5ST3043
			110 V DC	1 MW	5ST3044
			24 V DC	1 MW	5ST3045

¹⁾ 5ST3805-1 handle coupler required

Further technical specifications

5ST304.

Standards		
Standards	IEC/EN	EN 60947-1
Supply		
Primary operating range		0.85 ... 1.1 × U_n
Rated frequency f_n		50/60 Hz
Contacts		
Minimum contact load		50 mA, 24 V
Tripping operations		Max. 2000
Service life, on average, with rated load	Actuations	20000
Safety		
Short-circuit protection		Miniature circuit breaker B/C 6 A or fuse gG 6 A
Connections		
Conductor cross-sections		0.5 ... 2.5 mm ² (AWG 22 ... 14)
Terminals	Max. tightening torque	0.8 Nm (6.8 lb-in)
Ambient conditions		
Permissible ambient temperature		−25 ... +55 °C
Permissible storage temperature		−40 ... +75 °C
Resistance to climate	Acc. to IEC 60068-2-30	28 cycles
Mounting position		Any
Shock at 11 ms half-sine	Acc. to IEC 60068-2-27	150 m/s ²
Resistance to vibrations at 10 ... 150 Hz	Acc. to IEC 60068-2-6	50 m/s ²

Electrical accessories



5ST3 remote control mechanisms (RC mech.)

- For locations that are spread out over a wide area or not permanently attended
- Permits direct and immediate access to the installation even if it is remote or in a location that is hard to access
- Permits fast reconnection after a fault
- Version with ARD with automatic restart
- Versions with ARD and Power with integrated auxiliary switches and fault signal contacts

Type of remote control mechanism	Display	Ambient temperature	Vibration and shock requirements	Rated operational voltage U_e	Mounting width (1 MW = 18 mm)	Article No.
Basic	–	–25 °C ... +45 °C	–	12 ... 30 V AC, 12 ... 48 V DC	1.5 MW	5ST3053
				177 ... 270 V AC	2 MW	5ST3054
Power	LED	–25 °C ... +45 °C	–	12 ... 30 V AC, 12 ... 48 V DC	2 MW	5ST3055
				177 ... 270 V AC	2 MW	5ST3056
Power with ARD	LED	–25 °C ... +45 °C	–	12 ... 30 V AC, 12 ... 48 V DC	2 MW	5ST3057
				177 ... 270 V AC	2 MW	5ST3058
Power with extended function	LED	–40 °C ... +70 °C	Acc. to EN 61373/ EN 50155 "1B"	12 ... 30 V AC, 12 ... 48 V DC	2 MW	5ST3070
				170 ... 277 V AC, 77 ... 286 V DC	2 MW	5ST3071

Further technical specifications

	5ST3053	5ST3054	5ST3055	5ST3056	5ST3057	5ST3058	5ST3070	5ST3071
Standards								
Standards	EN 50557 (VDE 0640-20)							
Supply								
Rated frequency f_n	50 ... 60 Hz							
Rated power dissipation in standby	≤ 1 VA							
Contacts								
Service life, on average, with rated load	Actuations	10000						
Number of remote switching operations per minute	2							
Number of automatic reclose attempts	–				3		–	
Cable length in the control circuit	≤ 1500 m						≤ 1500 m (DC)/ ≤ 200 m (AC)	
Sliding selector with locking device	–	■						
Integrated auxiliary switches	–		1CO; 2 A; 250 V					
Integrated fault signal contacts	–		1CO; 2 A; 250 V					
Connections								
Conductor cross-sections	0.5 ... 1.5 mm ² (AWG 14 ... 30)							
Terminal tightening torque	0.2 ... 0.25 Nm (2.0 lb-in)							
Ambient conditions								
Permissible storage temperature	–40 ... +55 °C					–40 ... +70 °C		
Degree of protection	IP20							
Degree of pollution for overvoltage category	3/II							

Suitable adapters for combination with basic units



Basic units	Mounting width			Article No.
	1 ... 2 MW	3 ... 4 MW	3 ... 6 MW	
5SY4/5/6/7/8	■	–	–	5ST3820-1
	–	■	–	5ST3820-2
5SL3/4/6	■	–	–	5ST3820-6
	–	■	–	5ST3820-7
5SL60/5SY17	■	–	–	5ST3820-6
5SP4, 5SP5	■	–	–	5ST3820-1
	–	–	■	5ST3820-2



5SM6 arc fault detection units (AFDD)

- Detects arcing faults
- Offers extremely effective protection against fires started by electrical faults
- Ensures adequate fire protection even in applications without residual current protective device

For combining with basic units			Rated current I_n	Mounting width (1 MW = 18 mm)	Article No.
Width of basic unit	Miniature circuit breakers	RCBOs			
1 MW	5SL60 1P + N (no KL types)	5SV1	Up to 16 A	1 MW	5SM6011-2
			Up to 40 A	1 MW	5SM6014-2
2 MW	5SY ¹⁾ , 5SL4 (1P+N devices only, not compact)	5SU1.5	Up to 16 A	1 MW	5SM6021-2
			Up to 40 A	1 MW	5SM6024-2

¹⁾ Not suitable for use with 5SY5, 5SY8

Further technical specifications

5SM6

Standards		
Standards		IEC/EN 62606
Supply		
Rated voltage U_n		230 V
Rated current I_n		Up to 16/40 A
Rated frequency		50 Hz
Power loss		0.6 W
Contacts		
Number of poles		2-pole
Service life	Average number of operating cycles	> 10000
Safety		
Touch protection	Acc. to EN 50274 (VDE 0660-514)	Finger and back-of-hand safe
Degree of protection	Acc. to EN 60529 (VDE 0470-1)	IP20, with connected conductors
Overvoltage category		III
Tripping in the event of overvoltage		> 275 V
Connections		
Terminal/conductor cross-sections	Solid and stranded	0.75 ... 16 mm ²
	Finely stranded with end sleeve	0.75 ... 10 mm ²
Terminal tightening torque		2.0 ... 2.5 Nm
Mains connection		Bottom
Ambient conditions		
Permissible ambient temperature		-25 ... +40 °C
Permissible storage temperature		-40 ... +75 °C
Resistance to climate at 95% relative humidity	Acc. to IEC 60068-2-30	28 cycles, 55 °C
Degree of pollution		2
CFC and silicone-free		Yes
Mounting position		Any

See suitable busbars, from page 3/62 onwards

See suitable terminals and end caps, from page 3/78 onwards

Mechanical accessories

Mechanical rotary operating mechanisms complete with handle



- For 5SY, 5SP4, 5SP5, 5SL (but not for 5SL.0 1P + N in 1MW), 5TL1, 5TE2, 5TE8, 5SU1

Types	Article No.
Handle black	5ST3060
Handle red/yellow	5ST3061

Terminal cover



- For miniature circuit breakers, but not for 5SL60..
- For additional covering of the screw openings per pole
- Lockable
- In the case of 5SY, also prevents removal of device from the DIN rail

	Article No.
	5ST3800

Handle locking devices

- To prevent undesired mechanical ON/OFF switching
- Sealable and lockable



For miniature circuit breakers	For padlocks with	Article No.
5SP4, 5SP5, 5SY	Max. 3 mm shackle	5ST3801
5SL, 5TL1	3 ... 6 mm shackle	5ST3806

Padlocks



- For 5ST3801 and 5ST3806 handle locking devices and remote control mechanisms 5ST3054 ... 58, 5ST3070

	Article No.
	5ST3802

Locking devices

- Comprising 5ST3801 or 5ST3806 handle locking device and 5ST3802 padlock

For miniature circuit breakers	Comprising	Article No.
5SP4, 5SP5, 5SY	5ST3801 handle locking device, 5ST3802 padlock	5ST3803
5SL, 5SV, 5TL1	5ST3806 handle locking device, 5ST3802 padlock	5ST3807

Spacers



- Can be placed on either side of the DIN rail. Two spacers allow for convenient cable routing

Mounting width	Article No.
0.5 MW	5TG8240

Device labels

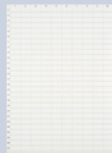

- For adhesive attachment
- For modular installation devices, e.g. 5SY, 5SL, 5TL1

Types	Article No.
15 × 6 mm, white (WIN 098)	8WH8210-0AA35
15 × 6 mm, yellow (WIN 099)	8WH8210-0AA36

Terminal covers, gray



- For surface mounting, degree of protection IP40
- Sealable
- Can be used with 35 mm DIN rail

For width up to	Article No.
2.5 MW	5SW3004
4.5 MW	5SW3005

Wall enclosures, gray



- For flush mounting, degree of protection IP40
- Can be used with 35 mm DIN rail

For width up to	Article No.
2.5 MW	5SW3006
4.5 MW	5SW3007

Covers



- Can be assembled as mini distribution board
- Suitable for all devices
- Cover parts prepared for rail mounting of conventional label caps

Comprising	Article No.
End plate	5ST2134
Angled profile	5ST2135
Flat profile as alternative	5ST2136

Holders for front panel installation



- Universal use for devices from 1 to 6 MW

Cutout height	Cutout width	Article No.
45 ^{+0.5} mm	23, 41, 59, 77, 95 or 113 mm	7LF9006

Intermediate frames



- For 70 mm devices in 55 mm ALPHA SIMBOX small distribution boards

Types	Article No.
1-tier	8GB4561
2-tier	8GB4562
3-tier	8GB4563
4-tier	8GB4564

Standard busbars

General information



Infeed

At the start or end of the busbar

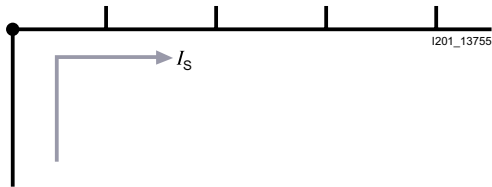

Maximum busbar current I_s /phase

- Cross-section 10 mm²: 63 A
- Cross-section 16 mm²: 80 A

Along the busbar or midpoint infeed

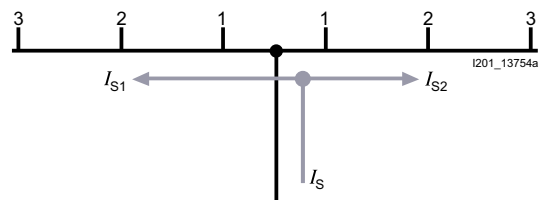

Maximum busbar current I_s /phase

- Cross-section 10 mm²: 100 A
- Cross-section 16 mm²: 130 A



Fixed lengths, cannot be cut

For miniature circuit breakers (MCBs)

Pin spacing in MW (1 MW = 18 mm)	Application	No. of MW	Length	Conductor cross-section	
				10 mm ²	16 mm ²
1-phase					
	For 2 MCBs 1P	2 MW	33 mm	5ST3600	5ST3630
	For 6 MCBs 1P	6 MW	105 mm	5ST3601	5ST3631
	For 12 MCBs 1P	12 MW	212 mm	5ST3602	5ST3632
	2-phase/1-phase + N				
	For 2 MCBs (2P/1P+N)	4 MW	76 mm	5ST3606	5ST3636
	For 3 MCBs (2P/1P+N)	6 MW	105 mm	5ST3607	5ST3637
	For 6 MCBs (2P/1P+N)	12 MW	210 mm	5ST3608	5ST3638
				\varnothing 10 mm ² \varnothing 16 mm ²	
3-phase					
	For 2 MCBs 3P	6 MW	102 mm	5ST3613	5ST3643
	For 3 MCBs 3P	9 MW	157.5 mm	5ST3614	5ST3644
	For 4 MCBs 3P	12 MW	210 mm	5ST3615	5ST3645
	For 14 MCBs 1P	14 MW	250 mm	5ST3613-4	–
	Combi pack: 20 × 5ST3613 + 10 × 5ST3614 + 50 × 5ST3615 + 50 × 5ST3655			5ST3656	–
	Combi pack: 20 × 5ST3643 + 10 × 5ST3644 + 50 × 5ST3645 + 50 × 5ST3655			–	5ST3657
				\varnothing 10 mm ² \varnothing 16 mm ²	
4-phase/3-phase + N					
	For 2 MCBs (4P/3P+N)	8 MW	138 mm/ 140 mm	5ST3621	5ST3651
	For 3 MCBs (4P/3P+N)	12 MW	210 mm	5ST3622	5ST3652
				\varnothing 10 mm ² \varnothing 16 mm ²	
	For 6 MCBs 1P+N	12 MW	210 mm	5ST3623	5ST3653
	For 7 MCBs 1P+N	14 MW	248 mm	5ST3623-4	–
				\varnothing 10 mm ² \varnothing 16 mm ²	

Standard busbars

Fixed lengths, cannot be cut

For MCBs equipped with auxiliary switch (AS) or fault signal contact (FC)

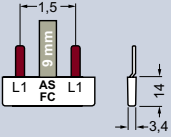
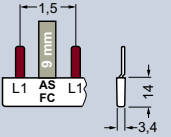
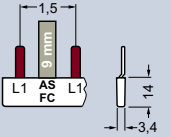
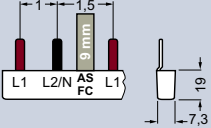
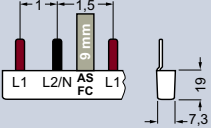
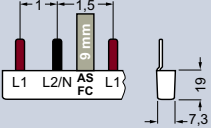
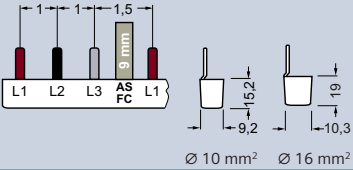
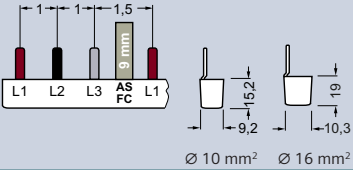
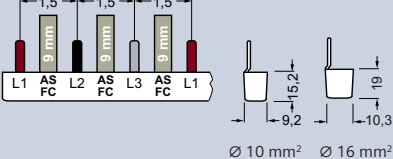
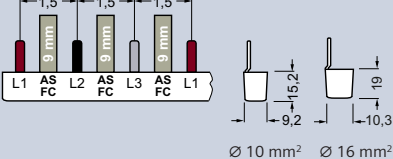
Pin spacing in MW (1 MW = 18 mm)	Application	No. of MW	Length	Conductor cross-section	
				10 mm ² Article No.	16 mm ² Article No.
1-phase					
	For 2 MCBs 1P	2 MW	40 mm	5ST3603	5ST3633
	For 6 MCBs 1P	6 MW	158 mm	5ST3604	5ST3634
	For 9 MCBs 1P	9 MW	237 mm	5ST3605	5ST3635
2-phase/1-phase + N					
	For 2 MCBs (2P/1P+N)	4 MW	76 mm	–	5ST3640
	For 3 MCBs (2P/1P+N)	6 MW	121 mm	–	5ST3641
	For 5 MCBs (2P/1P+N)	10 MW	210 mm	–	5ST3642
3-phase					
	For 2 MCBs 3P	6 MW	115 mm	5ST3616	5ST3646
	For 4 MCBs 3P	12 MW	237 mm	5ST3617	5ST3647
	For 6 MCBs 1P	9 MW	156 mm/ 158 mm	5ST3618	5ST3648
	For 9 MCBs 1P	12 MW	227 mm	5ST3620	5ST3650

Accessories

Terminals for 5ST36 and 5ST37			Terminals for infeed at side		
		Article No.			Article No.
For conductors 6 ... 25 mm ²	Cable entry on the left	5ST3768-4	For conductors 6 ... 25 mm ²	Short	5ST3768
	Cable entry in the center	5ST3768-3		Short, IP20	5ST3771-2
	Cable entry on the right	5ST3768-5	Touch protection		
For conductors 6 ... 50 mm ²	Cable entry on the left	5ST3760-4	For free connections, yellow (RAL 1004) 5 × 1 pin		5ST3655
	Cable entry in the center	5ST3760-3			
	Cable entry on the right	5ST3760-5			

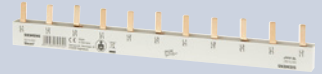

For MCBs with RCCB

Pin spacing in MW
(1 MW = 18 mm)

3-phase

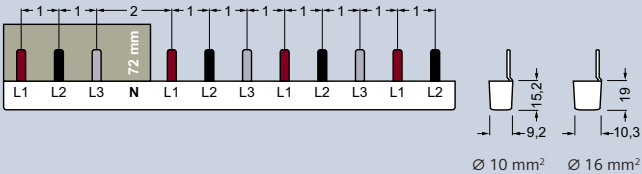

Application	No. of MW	Length	Conductor cross-section 10 mm ² Article No.	16 mm ² Article No.
For 8 MCBs 1P with 1 RCCB 3P+N, N right	12 MW	210 mm	5ST3624	5ST3654

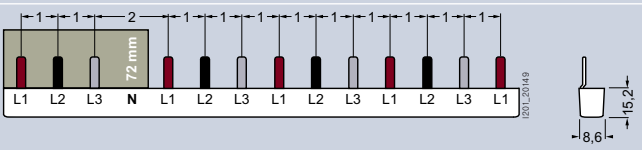

For 10 MCBs 1P with 1 RCCB 3P+N or for 1 RCCB 3P+N, 1 MCB 3P and 7 MCBs 1P	14 MW	249 mm	5ST3624-4	-
--	-------	--------	-----------	---

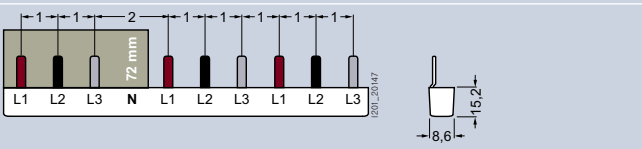

For 6 MCBs 1P with 1 RCCB 3P+N or for 1 RCCB 3P+N, 1 MCB 3P and 3 MCBs 1P	10 MW	176 mm	5ST3624-1	-
---	-------	--------	-----------	---



For 8 MCBs 1P with 1 RCCB 3P+N, N left	11 MW	192 mm	5ST3667	5ST3668
--	-------	--------	---------	---------

4-phase/3-phase + N

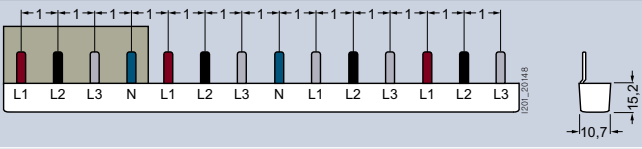

Application	No. of MW	Length	Article No.	Article No.
For 1 RCCB 3P+N, 1 MCB 3P+N and 6 MCBs 1P	14 MW	248 mm	5ST3724-4	-

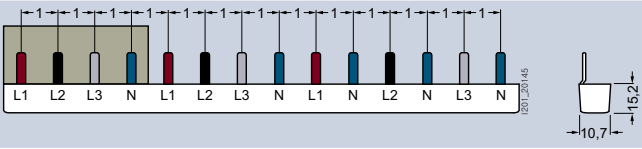

For 1 RCCB 3P+N, 1 MCB 3P+N and 3 MCBs 1P+N	14 MW	248 mm	5ST3725-4	-
---	-------	--------	-----------	---

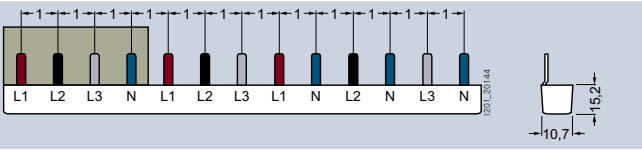

For 1 RCCB 3P+N, 1 MCB 3P and 3 MCBs 1P+N	13 MW	230 mm	5ST3725-3	-
---	-------	--------	-----------	---

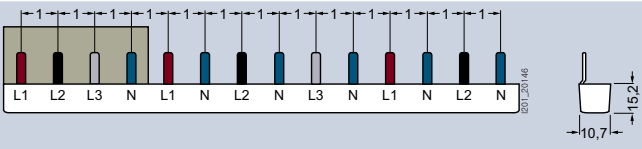



For 1 RCCB 3P+N and 5 MCBs 1P+N	14 MW	248 mm	5ST3625-4	-
---------------------------------	-------	--------	-----------	---

Standard busbars

Can be cut

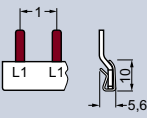
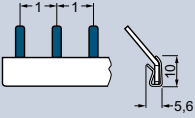
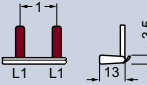
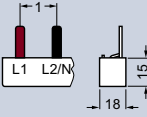
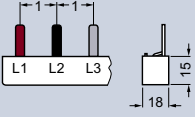
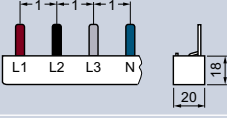
For miniature circuit breakers (MCBs)

Pin spacing in MW (1 MW = 18 mm)	Application	No. of MW	Length	End caps included	Color	Conductor cross-section		
						10 mm ²	16 mm ²	
						Article No.	Article No.	
1-phase, straight 	For MCBs 1P+N compact	12 MW	216 mm	■	Gray	5ST3762	–	
						5ST3687-0	–	
		56 MW	1016 mm	–	–	Gray	5ST3764	–
						Blue	5ST3787-0	–
1-phase, angled 45° 	For MCBs 1P+N compact	12 MW	216 mm	■	Blue	5ST3763	–	
						56 MW	1016 mm	–
1-phase, angled 90° 	For MCBs 1P	12 MW	214 mm	■	–	5ST3730	5ST3700	
						56 MW	1016 mm	–
2-phase/1-phase + N 	For 2MW devices (2P/1P+N)	12 MW	214 mm	■	–	5ST3734	5ST3704	
						56 MW	1016 mm	–
3-phase 	For MCBs 3P	12 MW	214 mm	■	–	5ST3738	5ST3708	
						56 MW	1016 mm	–
4-phase/3-phase + N 	For MCBs 4P or 3P+N	12 MW	214 mm	■	–	5ST3745	5ST3715	
						56 MW	1016 mm	–
	For RCCB/MCBs or MCBs 1P+N	56 MW	1000 mm	–	–	5ST3770-2	5ST3770-3	
						–	–	–

Accessories

Terminals for 5ST36 and 5ST37		Article No.
For conductors 6 ... 25 mm ²	Cable entry on the left	5ST3768-4
	Cable entry in the center	5ST3768-3
	Cable entry on the right	5ST3768-5
For conductors 6 ... 50 mm ²	Cable entry on the left	5ST3760-4
	Cable entry in the center	5ST3760-3
	Cable entry on the right	5ST3760-5
Terminals for Infeed at side		Article No.
For conductors 6 ... 25 mm ²	Short	5ST3768
	Short, IP20	5ST3771-2

End caps		Article No.
For 1-phase busbars (MCB 1P+N compact)	Gray	5ST3766
	Blue	5ST3767
	White	5ST3748
For 2 and 3-phase busbars		5ST3750
Touch protection		Article No.
For free connections, yellow (RAL 1004) 5 × 1 pin		5ST3655

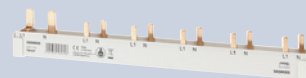

For MCBs equipped with auxiliary switch (AS) or fault signal contact (FC)

Pin spacing in MW (1 MW = 18 mm)	Application	No. of MW	Length	End caps included	Conductor cross-section	
					10 mm ²	16 mm ²
1-phase, angled 90° 	For MCBs 1P	12 MW	214 mm	■	Article No.	Article No.
		56 MW	1016 mm	–	5ST3732	5ST3702
2-phase/1-phase + N 	For 2 MW devices (2P/1P+N)	12 MW	214 mm	■	Article No.	Article No.
		56 MW	1016 mm	–	5ST3736	5ST3706
3-phase 	For MCBs 3P	12 MW	214 mm	■	Article No.	Article No.
		56 MW	1016 mm	–	5ST3741	5ST3711
	For MCBs 1P	12 MW	214 mm	■	5ST3743	5ST3713
		56 MW	1016 mm	–	5ST3744	5ST3714
4-phase/3-phase + N 	For MCBs 1P+N	56 MW	1016 mm	–	Article No.	Article No.
					5ST3746-2	–

For MCBs equipped with undervoltage release (UR) or shunt trips (ST)

Pin spacing in MW (1 MW = 18 mm)	Application	No. of MW	Length	End caps included	Conductor cross-section	
					10 mm ²	16 mm ²
2-phase 	For MCBs 1P with UR/ST	56 MW	1016 mm	–	Article No.	Article No.
					5ST3735-2	–

Standard busbars

Can be cut



For MCBs with line-side RCCB or RCCBs equipped with AS/FC devices

Pin spacing in MW (1 MW = 18 mm)	Application	No. of MW	Length	End caps included	Conductor cross-section	
					10 mm ²	16 mm ²
4-phase/3-phase + N					Article No.	Article No.
	For RCCB/MCBs	56 MW	1016 mm	–	5ST3746-2	–
	For 6 MCBs 1P+N with 1 RCCB 3P+N, N right	16 MW	292 mm	■	5ST3770-4	5ST3770-5

Accessories

Terminals for 5ST36 and 5ST37		Article No.
For conductors 6 ... 25 mm ²	Cable entry on the left	5ST3768-4
	Cable entry in the center	5ST3768-3
	Cable entry on the right	5ST3768-5
For conductors 6 ... 50 mm ²	Cable entry on the left	5ST3760-4
	Cable entry in the center	5ST3760-3
	Cable entry on the right	5ST3760-5

End caps	Article No.
For 2 and 3-phase busbars	5ST3750
For 4-phase busbars	5ST3718
Touch protection	Article No.
For free connections, yellow (RAL 1004) 5 × 1 pin	5ST3655



5ST37 acc. to UL 508, can be cut

For miniature circuit breakers (MCBs)

Pin spacing in MW (1 MW = 18 mm)	Application	No. of MW	Length	Conductor cross-section	
				18 mm ²	25 mm ²
1-phase					
	For MCBs 1P or fuse holders 10 × 38 mm/class CC	56 MW	1000 mm	Article No. 5ST3701-0HG	Article No. –
	For MCBs 1P or fuse holders 14 × 51 mm	56 MW	1000 mm	–	Article No. 5ST3701-2HG
2-phase					
	For MCBs 2P or fuse holders 10 × 38 mm/class CC	56 MW	1000 mm	Article No. 5ST3705-0HG	Article No. –
	For MCBs 2P or fuse holders 14 × 51 mm	56 MW	1000 mm	–	Article No. 5ST3705-2HG
3-phase					
	For MCBs 3P or fuse holders 10 × 38 mm/class CC	56 MW	1000 mm	Article No. 5ST3710-0HG	Article No. –
	For MCBs 3P or fuse holders 14 × 51 mm	56 MW	1000 mm	–	Article No. 5ST3710-2HG

3

Standard busbars

5ST37 acc. to UL 508, can be cut



For MCBs equipped with auxiliary switch (AS) or fault signal contact (FC)

Pin spacing in MW (1 MW = 18 mm)	Application	No. of MW	Length	Conductor cross-section	
				18 mm ²	25 mm ²
1-phase					
	For MCBs 1P	56 MW	1000 mm	Article No. 5ST3703-OHG	Article No. –
2-phase					
	For MCBs 2P	56 MW	1000 mm	Article No. 5ST3707-OHG	Article No. –
3-phase					
	For MCBs 3P	56 MW	1000 mm	Article No. 5ST3712-OHG	Article No. –
	For MCBs 1P	56 MW	1000 mm	Article No. 5ST3714-OHG	Article No. –

Accessories

Terminals according to UL 508		Article No.	
For infeed at the device	6 ... 35 mm ²	5ST3770-OHG	
For infeed at the busbar	2.5 ... 50 mm ²	5ST3770-1HG	
End caps according to UL 508		Article No.	
For 1-phase busbars		5ST3748-OHG	
For 2 and 3-phase busbars		5ST3750-OHG	
Touch protection according to UL 508		Article No.	
For open terminals, yellow 5 × 1 pin		5ST3655-OHG	



5ST3.. acc. to UL 489 specially for 5SJ4... -HG..

Fixed lengths, cannot be cut, for miniature circuit breakers (MCBs)¹⁾

Pin spacing in MW (1 MW = 18 mm)	Application	No. of MW	Length	Conductor cross-section 16 mm ²
1-phase				
	For 6 MCBs 1P	6 MW	100 mm	Article No. 5ST3663-0HG
	For 12 MCBs 1P	12 MW	205 mm	5ST3663-1HG
	For 18 MCBs 1P	18 MW	310 mm	5ST3663-2HG
2-phase				
	For 3 MCBs 2P	6 MW	100 mm	Article No. 5ST3664-0HG
	For 6 MCBs 2P	12 MW	205 mm	5ST3664-1HG
	For 9 MCBs 2P	18 MW	310 mm	5ST3664-2HG
3-phase				
	For 2 MCBs 3P	6 MW	100 mm	Article No. 5ST3665-0HG
	For 4 MCBs 3P	12 MW	205 mm	5ST3665-1HG
	For 6 MCBs 3P	18 MW	310 mm	5ST3665-2HG

¹⁾All unassigned pins of the busbars that cannot be cut must be covered with 5ST3666-1HG touch protection covers.

Can be cut, for MCBs

Pin spacing in MW (1 MW = 18 mm)	Application	No. of MW	Length	Conductor cross-section 18 mm ²
1-phase				
	For MCBs 1P	56 MW	1016 mm	Article No. 5ST3701-3HG
2-phase				
	For MCBs 2P	56 MW	1016 mm	Article No. 5ST3705-3HG
3-phase				
	For MCBs 3P	56 MW	1016 mm	Article No. 5ST3710-3HG

Standard busbars

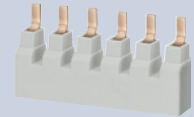

5ST3.. acc. to UL 489 specially for 5SJ4...-.HG..

Can be cut, for MCBs equipped with auxiliary switch (AS) or fault signal contact (FC)

Pin spacing in MW (1 MW = 18 mm)	Application	No. of MW	Length	Conductor cross-section 18 mm ²
1-phase				
	For MCBs 1P	56 MW	1016 mm	Article No. 5ST3703-3HG
2-phase				
	For MCBs 2P	56 MW	1016 mm	Article No. 5ST3707-3HG
3-phase				
	For MCBs 3P	56 MW	1016 mm	Article No. 5ST3712-3HG
	For MCBs 1P	56 MW	1016 mm	Article No. 5ST3714-3HG

Accessories

Terminals according to UL 489		Article No.	Touch protection according to UL 489		Article No.
For infeed at the 5SJ4...-.HG.. miniature circuit breaker	2.5 ... 35 mm ²	5ST3666-0HG	For open terminals, yellow 3 × 1 pin	For 5ST37...-HG busbars that cannot be cut	5ST3666-1HG
	6 ... 35 mm ²	5ST3770-3HG		For 5ST37...-3HG busbars that can be cut	5ST3655-3HG
For infeed at the busbar	2.5 ... 50 mm ²	5ST3666-2HG			
End caps according to UL 489		Article No.			
For 1, 2 and 3-phase busbars		5ST3750-3HG			

Compact busbars

General information



Infeed

At the start or end of the busbar

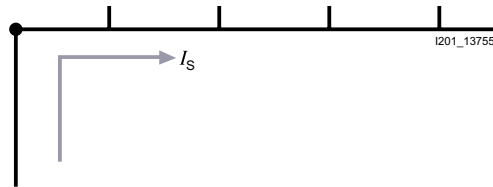

Maximum busbar current I_s /phase

- Cross-section 10 mm²: 63 A
- Cross-section 16 mm²: 80 A

Along the busbar or midpoint infeed

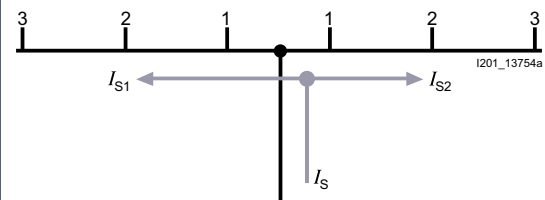

Maximum busbar current I_s /phase

- Cross-section 10 mm²: 100 A
- Cross-section 16 mm²: 130 A

Compact busbars

5ST36, fixed lengths, cannot be cut

Pin spacing in MW (1 MW = 18 mm)	Application	No. of MW	Length	End caps included	Conductor cross-section 10 mm ²
2-phase/1-phase + N, for infeed via RCCB					
	For 1 × RCCB 1P+N and 5 × compact devices equipped with 5SM6 arc fault detection unit	12 MW	216 mm	■	Article No. 5ST3685-0
2-phase/1-phase + N					
	For compact devices	6 MW	113 mm	■	Article No. 5ST3674-6
		9 MW	166 mm	■	5ST3674-7
		12 MW	218 mm	■	5ST3674-0
	For 12 × 5SY17 CBE (circuit breaker for equipment)	12 MW	218 mm	■	5ST3674-1
	For 6 × compact devices equipped with 5SM6 arc fault detection unit	11 MW	200 mm	■	5ST3676-0
4-phase/3-phase + N					
	For compact devices	6 MW	113 mm	■	Article No. 5ST3673-6
		9 MW	116 mm	■	5ST3673-7
		12 MW	218 mm	■	5ST3673-0
		14 MW	254 mm	■	5ST3673-4
	For 6 × compact devices equipped with 5SM6 arc fault detection unit	11 MW	200 mm	■	5ST3675-0

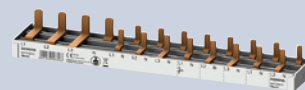

5ST37, can be cut

Pin spacing in MW (1 MW = 18 mm)	Application	No. of MW	Length	End caps included	Conductor cross-section 10 mm ²	Article No.
2-phase/1-phase + N, for infeed via RCCB						
	For 1 × RCCB 1P+N and 10 × compact devices	12 MW	215 mm	■		5ST3784-0
	For 1 × RCCB 1P+N (RCCB N left only) and 10 × compact devices	12 MW	215 mm	■		5ST3784-OKL
2-phase/1-phase + N						
	For compact devices	60 MW	1060 mm	–		5ST3774-0
	For compact devices equipped with 5SM6 arc fault detection unit	59 MW	1042 mm	–		5ST3776-0
	For compact devices equipped with auxiliary switch	59.5 MW	1055 mm	–		5ST3778-0
	For compact devices equipped with 5SM6 arc fault detection unit and auxiliary switch	58.5 MW	1036 mm	–		5ST3780-0
	For 2 MW units (MCBs or RCBOs) with mounted 5SM6 arc fault detection unit and auxiliary switch	54 MW	956 mm	–		5ST3786-0

Accessories

Terminals for infeed at side	Article No.	Touch protection	Article No.
For conductors 6 ... 25 mm ² Short, IP20	5ST3771-2	For free connections, yellow (RAL 1004)	5ST3655
End caps	Article No.	For pins L2, L3	5ST3655-0HG
For 2 and 4-phase compact busbars	5ST3788-0		

Compact busbars

5ST37, can be cut

Pin spacing in MW (1 MW = 18 mm)	Application	No. of MW	Length	End caps included	Conductor cross-section 10 mm ²	Article No.
4-phase/3-phase + N, for infeed via RCCB						
	For 1 × RCCB 3P+N and 6 × compact devices	10 MW	181 mm	■		5ST3783-1
	For 1 × RCCB 3P+N and 8 × compact devices	12 MW	216 mm	■		5ST3783-0
	For 1 × RCCB 3P+N and 10 × compact devices	14 MW	251 mm	■		5ST3783-4
	For 1 × RCCB 3P+N (RCCB N left only) and 6 × compact devices	10 MW	181 mm	■		5ST3783-1KL
	For 1 × RCCB 3P+N (RCCB N left only) and 8 × compact devices	12 MW	216 mm	■		5ST3783-0KL
	For 1 × RCCB 3P+N, 1 × MCBs 3P and 7 × compact devices	14 MW	253 mm	■		5ST3785-4
	For 1 × RCCB 3P+N, 2 × MCBs 3P+N and 12 × compact devices	24 MW	430 mm	■		5ST3790-1
	For 1 × RCCB 3P+N, 2 × MCBs 3P+N and 45 × compact devices	57 MW	1009 mm	–		5ST3790-2
	For 1 × RCCB 3P+N, 1 × MCBs 3P+N and 4 × compact devices	12 MW	217 mm	■		5ST3795-0
	For 1 × RCCB 3P+N, 1 × MCBs 3P+N and 6 × compact devices	14 MW	253 mm	■		5ST3795-4

3



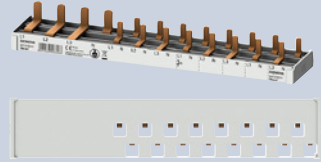

Pin spacing in MW (1 MW = 18 mm)	Application	No. of MW	Length	End caps included	Conductor cross-section 10 mm ²	Article No.
4-phase/3-phase + N 	For compact devices	60 MW	1060 mm	–		5ST3773-0
	For compact devices equipped with 5SM6 arc fault detection unit	59 MW	1042 mm	–		5ST3775-0
	For compact devices equipped with auxiliary switch	59.5 MW	1055 mm	–		5ST3777-0

3







Accessories

Terminals for infeed at side	Article No.	Touch protection	Article No.
For conductors 6 ... 25 mm ² Short, IP20	5ST3771-2	For free connections,	For pins L1, N
		yellow (RAL 1004)	5ST3655
End caps	Article No.		For pins L2, L3
For 2 and 4-phase compact busbars	5ST3788-0		5ST3655-0HG

Accessories for busbars

General accessories

Terminals

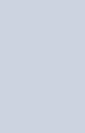
	For conductors	Version	Cable entry	Infeed	Article No.
	6 ... 25 mm ²	Short	–	Lateral	5ST3768
		Short, IP20	–	Lateral	5ST3771-2
	6 ... 25 mm ²	–	Center	–	5ST3768-3
			Left	–	5ST3768-4
			Right	–	5ST3768-5
	6 ... 50 mm ²	–	Center	–	5ST3760-3
			Left	–	5ST3760-4
			Right	–	5ST3760-5
	2.5 ... 50 mm ²	–	–	Busbar	5ST3770-1HG
	6 ... 35 mm ²	–	–	Device	5ST3770-0HG
	2.5 ... 35 mm ²	For 5SJ4... -HG..	–	Miniature circuit breaker	5ST3666-0HG
	6 ... 35 mm ²	For 5ST37..-3HG that can be cut	–	Miniature circuit breaker	5ST3770-3HG
	2.5 ... 50 mm ²	–	–	Busbar	5ST3666-2HG

5ST36	5ST37	5ST37 (acc. to UL 508)	5ST3.. (acc. to UL 489)	5ST3 compact
■	■			■
■	■			
	■			
	■			
	■			
	■			
		■		
		■		
			■	
			■	
			■	

Accessories for busbars

General accessories

Touch protection



Version	Scope of supply	Version	Article No.
For free connections, yellow (RAL 1004)	5 × 1 pin	–	5ST3655
			5ST3655-0HG
	3 × 1 pin	–	5ST3666-1HG
		–	5ST3655-3HG
For conductors 10 mm ²	20 × 5ST3613 + 10 × 5ST3614 + 50 × 5ST3615 + 50 × 5ST3655	–	5ST3656
For conductors 16 mm ²	20 × 5ST3643 + 10 × 5ST3644 + 50 × 5ST3645 + 50 × 5ST3655	For 5ST337...3HG	5ST3657

End caps

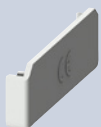
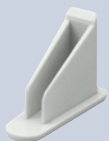



Version	Color	Article No.
For 1-phase busbars	Gray	5ST3748
For 2 and 3-phase busbars	Gray	5ST3750
For 4-phase busbars	Gray	5ST3718
For 1, 2 and 3-phase busbars	Gray	5ST3750-3HG
–	Gray	5ST3766
	Blue	5ST3767
For 1-phase busbars	Gray	5ST3748-0HG
For 2 and 3-phase busbars	Gray	5ST3750-0HG
For 2 and 4-phase compact busbars	Gray	5ST3788-0

5ST36	5ST37	5ST37 (acc. to UL 508)	5ST3.. (acc. to UL 489)	5ST3 compact
■		■		■
			■	■
			■	
■				
■				
	■			
	■			
	■			
■			■	
■				
			■	
			■	
				■

Accessories for busbars

General accessories

Series connectors

	Conductor cross-section	Length of cable	Color	Number of phases	Article No.
	10 mm ²	125 mm	N conductor blue	1	5ST3781-0
			Cable black	1	5ST3791-0
				3	5ST3793-0
	150 mm	N conductor blue	1	5ST3781-1	
		Cable black	1	5ST3791-1	
			3	5ST3793-1	
	16 mm ²	125 mm	N conductor blue	1	5ST3782-0
			Cable black	1	5ST3792-0
				3	5ST3794-0
	150 mm	N conductor blue	1	5ST3782-1	
		Cable black	1	5ST3792-1	
			3	5ST3794-1	
	200 mm	N conductor blue	1	5ST3781-2	
		Cable black	1	5ST3791-2	
			3	5ST3793-2	
		3 × cables black and 1 × N conductor blue	3+N	5ST3793-3	

3

Distribution blocks for DIN-rail mounting

Acc. to IEC

Distribution blocks acc. to IEC

	Number of poles	Rated operational voltage U_e	Rated current I_n	Mounting width	Article No.
	4-pole	690 V AC	80 A	5 MW	5ST2501
			125 A	5.5 MW	5ST2502
			160 A	9 MW	5ST2503

Further technical specifications

Further technical specifications		5ST2501	5ST2502	5ST2503	
Standards					
Standards		IEC 60947-7-1			
Supply					
Rated operational voltage AC		690 V			
Max. rated current		80 A	125 A	160 A	
Conductor cross-section					
Inputs per pole	Solid/stranded	1 × 2.5 ... 16 mm ²	1 × 6 ... 35 mm ²	1 × 10 ... 50 mm ²	
	Finely stranded with end sleeve	1 × 1.5 ... 10 mm ²	1 × 6 ... 25 mm ²	1 × 10 ... 35 mm ²	
Outputs per pole	Solid/stranded	8 × 1.5 ... 10 mm ²	5 × 1.5 ... 6 mm ² 2 × 4 ... 16 mm ²	8 × 2.5 ... 16 mm ² 3 × 10 ... 35 mm ²	
	Finely stranded with end sleeve	8 × 1.5 ... 10 mm ²	5 × 1.5 ... 6 mm ² (small) 2 × 4 ... 10 mm ² (large)	8 × 1.5 ... 16 mm ² (small) 3 × 10 ... 25 mm ² (large)	
Tightening torque					
Inputs	Screw terminals	13.5 lb-in (1.5 Nm)		3.5 ... 5 lb-in (2 Nm)	
	Tools	PZ2			
Outputs	Screw terminals	Large	13.5 lb-in (1.5 Nm)		
		Small	–	7.2 lb-in (0.8 Nm)	13.5 lb-in (1.5 Nm)
	Tools	Large	PZ1	PZ2	
		Small	–	PZ1	PZ2
Safety					
Rated peak withstand current I_{pk}		21.6 kA	24 kA	20 kA	
Rated short-time withstand current I_{cw} (1 s)		3 kA	4.2 kA	6.2 kA	
Ambient conditions					
Permissible ambient temperature		–25 ... +70 °C			
Degree of protection	Acc. to EN 60529	IP20			
Approved cable		Copper			

According to IEC and UL

Distribution blocks acc. to IEC and UL					
	Number of poles	Rated operational voltage U_e	Rated current I_n	Mounting width	Article No.
	1-pole	600 V AC	80 A	1.5 MW	5ST2504
			125 A	1.5 MW	5ST2505
			160 A	2 MW	5ST2507
			250 A	2.5 MW	5ST2508
			350 A	2.5 MW	5ST2511

Connector for 5ST2505 distribution board	
	<ul style="list-style-type: none"> • Touch protection • 20 mm² • 32 mm²
Version	Article No.
1-phase	5ST2506

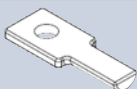
Terminal lug for ring terminal ends	
	
Types	Article No.
For 5ST2508 distribution block	5ST2510
For 5ST2511 distribution block	5ST2512

Further technical specifications		5ST2504	5ST2505	5ST2507	5ST2508	5ST2511		
Standards								
Standards		UL 1059/UL 486E/IEC 60947-7-1 UL File No. E80027/XCFR2 C22.2 No. 158 -1987/XCFR8						
Supply								
Rated operational voltage		UL	600 V AC					
		IEC	1000/1500 V AC/DC					
Max. rated current		UL	80 A	115 A	160 A	230 A	310 A	
		IEC	80 A	125 A	160 A	250 A	400 A	
Conductor cross-section								
Inputs per pole	Solid/stranded	Large	3 × 2.5 ... 25 mm ²	10 ... 35 mm ²	10 ... 70 mm ²	35 ... 120 mm ²	95 ... 185 mm ²	
			AWG 3 × 14 ... 4	AWG 1 × 8 ... 2	AWG 1 × 8 ... 2/0	AWG 1 × 2 ... 4/0	AWG 1 × 3/0 ... 350 MCM	
		Small	–	2.5 ... 25 mm ²	–	–	–	–
			–	–	AWG 1 × 14 ... 6	–	–	–
	Finely stranded with end sleeve	Large	3 × 2.5 ... 16 mm ²	10 ... 35 mm ²	10 ... 50 mm ²	35 ... 95 mm ²	95 ... 150 mm ²	
			AWG 3 × 14 ... 6	AWG 1 × 8 ... 2	AWG 1 × 8 ... 1	AWG 1 × 2 ... 3/0	AWG 3/0 ... 300 MCM	
		Small	–	2.5 ... 25 mm ²	–	–	–	–
			–	–	AWG 1 × 14 ... 6	–	–	–
Outputs per pole	Solid/stranded	Top	2.5 ... 6 mm ²	2.5 ... 16 mm ²		2.5 ... 10 mm ²	2 × 2.5... 35 mm ²	
			AWG 4 × 14 ... 10	AWG 6 × 14 ... 4		AWG 4 × 16 ... 8	AWG 2 × 14 ... 2	
		Center	–	–		2.5 ... 16 mm ²	5 × 2.5 ... 16 mm ²	
			–	–		AWG 5 × 14 ... 6	–	
		Bottom	2.5 ... 6 mm ²	–	–		2 × 2.5... 35 mm ²	4 × 2.5 ... 10 mm ²
			AWG 4 × 14 ... 10	–	–		AWG 2 × 14 ... 2	AWG 4 × 14 ... 8
	Finely stranded with end sleeve	Top	2.5 ... 6 mm ²	2.5 ... 16 mm ²		2 × 2.5... 25 mm ²		
			AWG 4 × 14 ... 10	AWG 6 × 14 ... 6	AWG 6 × 14 ... 4	AWG 2 × 14 ... 4		
		Bottom	2.5 ... 6 mm ²	–	–		2 × 2.5... 25 mm ²	4 × 2.5 ... 25 mm ²
			AWG 4 × 14 ... 10	–	–		AWG 2 × 14 ... 4	AWG 5 × 14 ... 4

Continued on next page

Distribution blocks for DIN-rail mounting

According to IEC and UL (continued)

Further technical specifications			5ST2504	5ST2505	5ST2507	5ST2508	5ST2511	
Tightening torque								
Inputs	Screw terminals		13.2 ... 26.5 lb-in (1.5 ... 3 Nm)	31 ... 44 lb-in (3.5 ... 5 Nm)	44 ... 53 lb-in (5 ... 6 Nm)	170 ... 186 lb-in (19 ... 21 Nm)	222 lb-in (25 Nm)	
	Tools		PZ2	Allen key 4 mm	Allen key 5 mm	Allen key 6 mm	Allen key 8 mm	
Outputs	Screw terminals	Large	13.2 ... 26.5 lb-in (1.5 ... 3 Nm)	17.7 ... 26.5 lb-in (2 ... 3 Nm)	13.2 ... 26.5 lb-in (1.5 ... 3 Nm)	31 ... 62 lb-in (3.5 ... 7 Nm)		
		Small	7 ... 13.2 lb-in (0.8 ... 1.5 Nm)	–		18 ... 27 lb-in (2 ... 3 Nm)		
	Tools	Large	PZ2			Standard screwdriver		
		Small	PZ1	PZ2		Standard screwdriver		
Safety								
Rated peak withstand current I_{pk}			2.7 kA	30 kA		51 kA		
Rated short-time withstand current I_{cw} (1 s)			1.9 kA	4.2 kA	11 kA	21 kA		
Overcurrent protection class			J					
Short circuit current rating (SCCR)	RMS Sym A		100 kA					
Electrical isolation	Creepage distances		1/2" (12.7 mm)					
	Clearances		3/8" (9.5 mm)					
Ambient conditions								
Permissible ambient temperature			–25 ... +70 °C					
Degree of protection	Acc. to EN 60529		IP20					
Fire class			UL 94V-0					
Approved cable			Copper					

SIKclip wiring system

SIKclip busbar



Length	Article No.
12 MW	5ST2520
24 MW	5ST2521
36 MW	5ST2522

Connecting cables with plug



Length	Conductor cross-section	Color	Article No.
120 mm	6 mm ²	Black	5ST2523
		Blue	5ST2524
	10 mm ²	Black	5ST2525
		Blue	5ST2526
200 mm	6 mm ²	Black	5ST2527
		Blue	5ST2528
	10 mm ²	Black	5ST2530
		Blue	5ST2531

Crimp connector



<ul style="list-style-type: none"> For connection to cables 4/6 mm² 	Article No.
	5ST2532

Mounting brackets



<ul style="list-style-type: none"> For mounting on the rear of the DIN rail (pair) 	Article No.
	5ST2533

Further technical specifications

5ST25..

Standards	
Test specifications	EN 60947-1, EN 61439-1
Rated values	
Rated operational voltage U_n	400 V AC
Max. rated current I_n	250 A
Max. rated output current I_n (at 40 °C ambient temperature)	63 A
Rated insulation voltage	660 V AC
Test voltage (50 Hz)	2.5 kV
Ambient conditions	
Degree of protection	IP20
Connecting cables	40 A (6 mm ²), 63 A (10 mm ²)
Connecting cable type	H07VK
Ambient temperature	-5 ... +60 °C



Appendix



Conditions of sale and delivery _____ A/2

Link directory _____ A/4

Conditions of sale and delivery

1. General Provisions

By using this catalog you can purchase hard- and software products as well as services (together hereinafter referred to as "products") described therein from Siemens Aktiengesellschaft subject to the following Terms and Conditions of Sale and Delivery (hereinafter referred to as "T&C"). Note, for products purchased from any Siemens entity having a registered office outside of Germany, the respective terms and conditions of sale and delivery of the respective Siemens entity apply exclusively. The following T&C apply exclusively for orders placed with Siemens Aktiengesellschaft, Germany.

1.1 For customers with a seat or registered office in European Union

For customers with a seat or registered office in European Union, the following terms and conditions apply subordinate to T&C:

- for products, which include specific terms and conditions in the text of the product description, these specific terms and conditions shall apply and subordinate thereto,
- for stand-alone software products and software products forming a part of a product or project, the "General Conditions for Software Products for Infrastructure & Industry Business (German law)"¹⁾ and/or
- for consulting services the "Allgemeine Geschäftsbedingungen für Beratungsleistungen für Infrastructure & Industry Geschäft (Deutsches Recht)"¹⁾ (available only in German) and/or
- for other services, the "Supplementary Terms and Conditions for Services for Infrastructure & Industry Business (German Law) ("BL")"¹⁾ and/or
- for other products the "General Conditions for the Supply of Products and Services of the Electrical and Electronics Industry"¹⁾.

In case such products should contain Open Source Software, the conditions of which shall prevail over the "General Conditions for the Supply of Products and Services of the Electrical and Electronics Industry"¹⁾, the Product will be given a note as to which special conditions apply to this open source software. This shall apply mutatis mutandis for notices referring to other third-party software components.

1.2 For customers with a seat or registered office outside European Union

For customers with a seat or registered office outside European Union, the following terms and conditions apply subordinate to T&C:

- for products, which include specific terms and conditions in the description text, these specific terms and conditions shall apply and subordinate thereto,
- for consulting services the "Standard Terms and Conditions for Consulting Services for Infrastructure & Industry Business (Swiss Law)"¹⁾ and/or
- for other services the "International Terms & Conditions for Services"¹⁾ supplemented by "Software Licensing Conditions"¹⁾ and/or
- for other products the "International Terms & Conditions for Products"¹⁾ supplemented by "Software Licensing Conditions"¹⁾

1.3 For customers with master or framework agreement

To the extent products offered are covered by an existing master or framework agreement, the terms and conditions of that agreement shall apply instead of T&C.

2. Additional Terms and Conditions

The dimensions are in mm. In Germany, according to the German law on units in measuring technology, data in inches apply only to devices for export.

Illustrations are not binding.

Insofar as there are no remarks on the individual pages of this catalog – especially with regard to data, dimensions and weights given – these are subject to change without prior notice.

¹⁾ The text of the Terms and Conditions of Siemens AG can be downloaded at https://mall.industry.siemens.com/legal/ww/en/terms_of_trade_en.pdf

3. Export Control and Sanctions Compliance

3.1 General

Customer shall comply with all applicable sanctions, embargoes and (re-)export control laws and regulations, and, in any event, with those of the European Union, the United States of America and any locally applicable jurisdiction (collectively "Export Regulations").

3.2 Checks for Products

Prior to any transaction by customer concerning products (including hardware, documentation and technology) delivered by Siemens, or products (including maintenance and technical support) performed by Siemens with a third party, customer shall check and certify by appropriate measures that

- (i) the customer's use, transfer, or distribution of such products, the brokering of contracts or the provision of other economic resources in connection with products will not be in violation of any Export Regulations, also taking into account any prohibitions to circumvent these (e.g., by undue diversion)
- (ii) the products are not intended or provided for prohibited or unauthorized non-civilian purposes (e.g. armaments, nuclear technology, weapons, or any other usage in the field of defense and military);
- (iii) customer has screened all direct and indirect parties involved in the receipt, use, transfer, or distribution of the products against all applicable restricted party lists of the Export Regulations concerning trading with entities, persons and organizations listed therein and
- (iv) products within the scope of items-related restrictions, as specified in the respective annexes to the Export Regulations, will not, unless permitted by the Export Regulations, be (a) exported, directly or indirectly (e.g., via Eurasian Economic Union (EAEU) countries), to Russia or Belarus, or (b) resold to any third party business partner that does not take a prior commitment not to export such products to Russia or Belarus.

3.3 Non-Acceptable Use of Software and Cloud Services

Customer shall not, unless permitted by the Export Regulations or respective governmental licenses or approvals,

- (i) download, install, access or use the products from or in any location prohibited by or subject to comprehensive sanctions or subject to license requirements according to the Export Regulations;
 - (ii) grant access to, transfer, (re-)export (including any "deemed (re-)exports"), or otherwise make available the products to any entity, person, or organization identified on a restricted party list of the Export Regulations;
 - (iii) use the products for any purpose prohibited by the Export Regulations (e.g. use in connection with armaments, nuclear technology or weapons);
 - (iv) upload to a products platform any customer content unless it is non-controlled (e.g. in the EU: AL = N; in the U.S.: ECCN = N or EAR99);
 - (v) facilitate any of the afore mentioned activities by any user.
- Customer shall provide all users with all information necessary to ensure compliance with the Export Regulations.

3.4 Semiconductor Development

Customer will not, without advance written authorization from Siemens, use offerings for the development or production of integrated circuits at any semiconductor fabrication facility located in China meeting the criteria specified in the U.S. Export Administration Regulations, 15 C.F.R. 744.23.

3.5 Information

Upon request by Siemens, customer shall promptly provide Siemens with all information pertaining to users, the intended use and the location of use or the final destination (in the case of hardware, documentation and technology) of the products. Customer will notify Siemens prior to customer disclosing any information to Siemens that is defense-related or requires controlled or special data handling pursuant to applicable government regulations, and will use the disclosure tools and methods specified by Siemens.

3.6 Reservation

Siemens shall not be obligated to fulfill this agreement if such fulfillment is prevented by any impediments arising out of national or international foreign trade or customs requirements or any embargoes or other sanctions. Customer acknowledges that Siemens may be obliged under the Export Regulations to limit or suspend access by customer and/or users to products.

4. Miscellaneous

Errors excepted and subject to change without prior notice.

Link directory

Catalog LV 10

General information

Information on low-voltage power distribution and electrical installation technology	www.siemens.com/lowvoltage
Tender specifications	www.siemens.com/tenderspecifications
Conversion tool	www.siemens.com/conversion-tool
Image database	www.siemens.com/lowvoltage/picturedb
CAX download manager	www.siemens.com/cax
Newsletter system	www.siemens.com/lowvoltage/newsletter
Siemens YouTube channel	www.youtube.com/Siemens
Catalog LV 10	www.siemens.com/lv10
Catalog LV 13	www.siemens.com/lv13
Catalog LV 18	www.siemens.com/lv18
Brochures/catalogs	www.siemens.com/lowvoltage/catalogs
Operating instructions/manuals	www.siemens.com/lowvoltage/manuals
SiePortal (knowledge base)	www.siemens.com/lowvoltage/product-support
SiePortal (product catalog)	www.siemens.com/lowvoltage/product-catalog
My Documentation Manager (MDM)	www.siemens.com/lowvoltage/mdm
Configurators	www.siemens.com/lowvoltage/configurators
Direct forwarding to SiePortal	www.siemens.com/product_catalog_SIEP?Article No.
Training	www.siemens.com/sitrain-lowvoltage
Local contacts	www.siemens.com/lowvoltage/contact www.siemens.com/lowvoltage/components/contact www.siemens.com/lowvoltage/systems/contact www.siemens.com/lowvoltage/software/contact
Technical Support	www.siemens.com/support-request
Information on services	www.siemens.com/service-offers
Control panels for the North American market	www.siemens.com/northamerican-standards
Integrated Control Panels	www.siemens.com/controlpanel
Energy savings and amortization	www.automation.siemens.com/sinasave
SIMATIC Energy Suite	www.siemens.com/energysuite
SITOP power supplies	www.siemens.com/sitop
Power distribution with Totally Integrated Power	www.siemens.com/tip
TIA Selection Tool	www.siemens.com/tst
Electrical Product Finder	www.siemens.com/electrical-product-finder
Sustainability	www.siemens.com/sustainability

Catalogs and further information



LV 10
Low-Voltage Power Distribution and Electrical Installation Technology
SENTRON • SIVACON • ALPHA
PDF (E86060-K8280-A101-B8-7600)



ET D1
Switches and Socket Outlets
DELTA
PDF (SIEP-C10409-00-7600)



LV 13
3WA Air Circuit Breakers
SENTRON
PDF (E86060-K8280-B101-A2-7600)



SiePortal
Information and Ordering Platform on the Internet:
sieportal.siemens.com



LV 18
Air Circuit Breakers and Molded Case Circuit Breakers with UL Certification
SENTRON
PDF (E86060-K8280-E347-B1-7600)



SITRAIN
Digital Industry Academy
www.siemens.com/sitrain



IC 10
Industrial Controls
SIRIUS
PDF (E86060-K1010-A101-B6-7600)



Siemens TIA Selection Tool
for the selection, configuration and ordering of TIA products and devices
www.siemens.com/tst

The catalogs listed above and additional catalogs are available in PDF format at www.siemens.com/lowvoltage/catalogs

Further information on low-voltage power distribution and electrical installation technology is available on the Internet at www.siemens.com/lowvoltage

Get more information

www.siemens.com/lowvoltage

Published by
Siemens AG

Smart Infrastructure
Electrical Products
Siemensstraße 10
93055 Regensburg, Germany

For the U.S. published by
Siemens Industry Inc.

100 Technology Drive
Alpharetta, GA 30005
United States

PDF (Catalog Extract
E86060-K8280-A101-B8-7600)
KG 1223 94 En
Produced in Germany
© Siemens 2023

Cybersecurity information

Siemens provides products and solutions with industrial cybersecurity functions that support the secure operation of plants, systems, machines and networks.

In order to protect plants, systems, machines and networks against cyber threats, it is necessary to implement – and continuously maintain – a holistic, state-of-the-art industrial cybersecurity concept. Siemens' products and solutions constitute one element of such a concept.

Customers are responsible for preventing unauthorized access to their plants, systems, machines and networks. Such systems, machines and components should only be connected to an enterprise network or the internet if and to the extent such a connection is necessary and only when appropriate security measures (e. g. firewalls and/or network segmentation) are in place.

For additional information on industrial cybersecurity measures that may be implemented, please visit www.siemens.com/cybersecurity-industry.

Siemens' products and solutions undergo continuous development to make them more secure. Siemens strongly recommends that product updates are applied as soon as they are available and that the latest product versions are used. Use of product versions that are no longer supported, and failure to apply the latest updates may increase customer's exposure to cyber threats.

To stay informed about product updates, subscribe to the Siemens Industrial Cybersecurity RSS Feed under www.siemens.com/cert.

Subject to changes and errors. The information given in this document only contains general descriptions and/or performance features which may not always specifically reflect those described, or which may undergo modification in the course of further development of the products. The requested performance features are binding only when they are expressly agreed upon in the concluded contract.

All product designations may be trademarks or other rights of Siemens AG, its affiliated companies or other companies whose use by third parties for their own purposes could violate the rights of the respective owner.